

**U.S. DEPARTMENT OF COMMERCE
NATIONAL OCEANIC AND ATMOSPHERIC ADMINISTRATION
NATIONAL WEATHER SERVICE
OFFICE OF SCIENCE AND TECHNOLOGY
METEOROLOGICAL DEVELOPMENT LABORATORY**

**Digital Weather Markup Language
Specification
(Version 1.0)**

7 May 2009

Table of Contents

List of Figures.....	i
List of Tables	ii
1. Overview:.....	1
1.1. DWML Requirements	1
1.2. DWML Structure.....	1
1.3. Sample Document	1
2. DWML Data Element Nomenclature:	1
3. Framework Elements:	2
3.1. <dwml> Element	2
3.1.1. <i>version</i> Attribute.....	2
3.2. <head> Element.....	2
3.3. <data> Element	2
4. DWML Metadata Elements	2
4.1. <product> Element	2
4.1.1. <i>concise-name</i> Attribute.....	3
4.1.2. <i>srsName</i> Attribute	3
4.1.3. <i>operational-mode</i> Attribute	3
4.1.4. <title> Element	3
4.1.5. <field> Element	3
4.1.6. <category> Element	4
4.1.7. <creation-date> Element	4
4.2. <source> Element.....	4
4.2.1. <more-information> Element	4
4.2.2. <production-center> Element.....	4
4.2.3. <disclaimer> Element	4
4.2.4. <credit> Element.....	5
4.2.5. <credit-logo> Element	5
4.2.6. <feedback> Element	5
5. DWML Data Elements	5
5.1. <location> Element	5
5.1.1. <location-key> Element.....	5
5.1.2. <point> Element.....	5
5.1.3. <city> Element.....	5
5.1.4. <nws-zone> Element	6
5.1.5. <area> Element	6
5.1.6. <point> Element.....	6
5.1.7. <point> Element.....	7
5.1.8. <point> Element.....	7
5.1.9. <point> Element.....	7
5.1.10. <point> Element.....	7
5.1.11. <height> Element	7
5.1.12. <level> Element	7
5.1.13. <layer> Element	8
5.2. <moreWeatherInformation> Element	8
5.2.1. <i>applicable-location</i> Attribute	8

5.3.	<time-layout> Element	8
5.3.1.	<i>time-coordinate</i> Attribute.....	8
5.3.2.	<layout-key> Element	8
5.3.3.	<start-valid-time> Element	9
5.3.4.	<end-valid-time> Element	9
5.4.	<parameters> Element	9
5.4.1.	<i>applicable-location</i> Attribute	9
5.4.2.	<temperature> Element	9
5.4.3.	<precipitation> Element	11
5.4.4.	<probability-of-precipitation> Element	12
5.4.5.	<convective-hazard> Element	13
5.4.6.	<wind-speed> Element	14
5.4.8.	<cloud-amount> Element	18
5.4.9.	<weather> Element	19
5.4.10.	<humidity> Element	20
5.4.11.	<conditions-icons> Element	21
5.4.12.	<wordedForecast> Element	22
5.4.13.	<water-state> Element	22
5.5.	<categorical-definitions> Element	26
5.5.1.	<categorical-table> Element	27
5.6.	<conversion-definitions> Element	27
5.6.1.	<conversion-table> Element	27
6.	Latitude and Longitude Lists	28
6.1.	<latLonList> Element	28
7.	Common Element and Attribute Definitions	28
7.1.1.	<i>latitude</i> Attribute	28
7.1.2.	<i>longitude</i> Attribute	28
7.2.	<i>vertical-coordinate</i> Attribute	28
7.3.	<i>summarization</i> Attribute.....	28
7.4.	<i>time-layout</i> Attribute.....	28
8.	XML Considerations	28
8.1.	Namespace	28
8.2.	Schema	28
8.3.	Character Set	29
Appendix A: DWML Requirements		30
1.	Overview	30
2.	XML Components	30
3.	DWML Validation	33
4.	General Characteristics	33
5.	Product Samples	33
Appendix B: Requirements Correlation Matrix		37
Appendix C: Data Model		39
Appendix D: Product Samples		46
Forecast at a Glance		46
NWS Web Site Product		46
Analogous DWML		46

Digital Tabular Forecast	49
Sample Digital Tabular Forecast Product.....	49
Analogous DWML	49
Digital Zone Forecast.....	54
Sample Digital Zone Forecast Product	54
Analogous DWML	54
Model Output Statistics Bulletin	58
Sample Model Output Statistics Product	58
Analogous DWML	58
Appendix E: Type Definitions.....	70
Appendix F: References	93

List of Figures

Figure 1. Example Forecast at a Glance Product.....	34
Figure 2. Example Digital/Tabular Forecast Product	34
Figure 3. Example Digital Zone Forecast Product.....	34
Figure 4. Forecast at a Glance.....	46
Figure 5. Digital/Tabular Forecast.....	49
Figure 6. Digital Zone Forecast	54
Figure 7: Sample Model Output Statistics Bulletin.	58

List of Tables

Table 1: DWML Content by Product.....	36
Table 2: Sky Cover to Text Conversion (Source: NWSI 10-503).....	82
Table 3: Valid Values for Weather Coverage Attribute.	83
Table 4: Valid Values for Weather Intensity.	83
Table 5: Valid Weather Values.....	83
Table 6: Valid Weather Attributes.....	84
Table 7: Valid Visibility Values.	84
Table 8: NDFDgen Night Time Icon Algorithm (priority in ascending order).	85
Table 9: NDFDgen Day Time Icon Algorithm (priority in ascending order).....	87
Table 10: NDFDgenByDay Night Time Icon Algorithm (format = '12 hourly') (priority in ascending order).....	88
Table 11: NDFDgenByDay Day Time Icon Algorithm (format = '12 hourly' or '24 hourly') (priority in ascending order).	90
Table 12: NDFDgenByDay Weather Summary Phrases (format = '12 hourly' or '24 hourly') (priority in ascending order).	92
Table 13: NDFDgenByDay Weather Summary Phrases (format = '12 hourly') (priority in ascending order).....	92

1. Overview:

This document defines the Digital Weather Markup Language (DWML). DWML is a new XML language which is being developed to initially support the exchange of the National Weather Service's (NWS) National Digital Forecast Database (NDFD) data. However, the specification is being written with enough flexibility to accommodate other environmental science applications. Appendix E provides a definition of DWML types based on restrictions appropriate to NDFD data. Other sets of restrictions similar to those in Appendix E need to be established for other specific implementations.

1.1. DWML Requirements

This specification attempts to include requirements in the MDL NDFD XML Requirements document (Appendix A). The matrix in Appendix B indicates which design feature satisfies which requirement.

1.2. DWML Structure

The tree diagrams in Appendix C provide a graphical representation of how DWML elements and attributes relate to each other. These relationships in concert with the DWML type definitions in Appendix E form the basis for language validation.

1.3. Sample Document

In addition to providing a definition of the elements and their attributes, this specification provides sample DWML documents in Appendix D for the three products proposed in the NDFD XML Requirements document. Appendix D also includes the application of DWML elements to a Model Output Statistics (MOS) bulletin. The MOS bulletin example is a non-NDFD example and so it does not conform to the NDFD type definitions. The MOS bulletin example is provided merely to illustrate the flexibility of DWLM to handle other data sources.

2. DWML Data Element Nomenclature:

This specification uses the following approach to describing elements:

- 1) Element and attribute names are all lower case.
- 2) Element and attribute names use a hyphen (“-”) to separate multiple word names so as to improve readability (ex. <creation-date>). Attribute and element names avoid the use of abbreviations to enhance readability.
- 3) Within this document, child elements are nested in a sub-paragraph under their parents.
- 4) Attributes are also nested but do not have the angle brackets (“<>”) and are italicized.
- 5) The element's and attribute's type is provided in braces (“{}”). For more information on each type refer to Appendix E.

- 6) If the element can occur zero or more times, an asterisk (“*”) is placed after its name. See specification 5.2.1.5 for an example.
- 7) If the element occurs zero or one times, a question mark (“?”) follows its name. See specification 4.1.3 for an example.
- 8) If the element must appear at least once, a plus sign (“+”) trails its name. See specification 5.2.1 for an example.
- 9) Element names without a special trailing character must occur exactly once. Specification 3.1 provides an example of an element that is required exactly once.
- 10) Each DWML specification references the requirement that it is designed to meet. The requirement is positioned at the end of the specification and contained in parentheses. For example, specification 3.1 satisfies requirement 4.2.
- 11) The order of element descriptions in the paragraphs below is not significant. Any required ordering of elements is specified in the tree diagrams found in Appendix C and type definitions in Appendix E.

3. Framework Elements:

3.1. <dwml> Element

The <dwml> element {dw:dwmlType}: The root element for DWML (R4.2).

3.1.1. *version* Attribute

The *version* attribute {xsd:string} indicates which version of DWML the instance contains (R2.1.3).

3.2. <head> Element

The <head> element {dw:headType} contains the metadata for the DWML instance. See section 4 for elements found in the <head> element (R4.2).

3.3. <data> Element

The <data> element {dw:dataType} contains the environmental data. See section 5 for child elements of the <data> element (R4.2 and R2.2).

4. DWML Metadata Elements

DWML metadata provides information about the DWML product and the data it contains. These elements are children of the <head> element.

4.1. <product> Element

The <product> element {dw:productType} holds meta information about the product.

4.1.1. *concise-name* Attribute

The *concise-name* attribute {dw:concise-nameType} represents a name or code that describes this product. The concise-nameType will have a list of names that is extensible to support secondary developer additions. Sample values include “glance”, “digital-tabular”, “digital-zone” (Derived From R2.1.1).

4.1.2. *srsName* Attribute

The srsName attribute {dw:srsNameType} communicates the spatial reference system used by NDFD. The NDFD spatial reference system is the “WGS 1984”.

4.1.3. *operational-mode* Attribute

The *operational-mode* attribute {dw:operational-modeType} defines the status of the product. Applications can review the content of this element to determine if they should perform further processing. Sample values include “test”, “developmental”, “experimental”, and “official” product. (R2.1.4)

4.1.3.1. Test Product

The “test” product indicates that this is an instance of an existing DWML product that contains some change being evaluated by a DWML development team. Users will typically not process this product (R2.1.4.1).

4.1.3.2. Developmental Product

The “developmental” product represents a new product that is not yet ready for public evaluation or use (R2.1.4.2).

4.1.3.3. Experimental Product

This product is available for testing and evaluation for a specified, limited time period for the explicit purpose of obtaining customer feedback. (R2.1.4.3).

4.1.3.4. Official Product

The “official” product identifies an instance of an established DWML product. This DWML instance is part of the approved product suite available from the NWS (R2.1.4.4).

4.1.4. <title> Element

The <title> element {xsd:string} [?] provides a concise summarization of what this DWML product contains (R2.1.1).

4.1.5. <field> Element

The <field> Element {dw:fieldType} specifies the general area within the environmental sciences that the data contained in the DWML instance is from. Example values include “meteorological”, “hydrological”, “oceanographical”, “land surface”, and “space” (R2.1.5).

4.1.6. <category> Element

The <category> Element {dw:categoryType} [?] defines the specific category that the product belongs to. Example values include “observation”, “forecast”, “analysis”, and “statistic” (R2.1.6).

4.1.7. <creation-date> Element

The <creation-date> Element {xsd:creation-dateType} contains the date and time that the product was prepared (R2.1.2).

4.1.7.1. *refresh-frequency* Attribute

The *refresh-frequency* attribute {xsd:duration} is used by the production center to help users know how often to return for updated data. In the case of the NDFD, the data is updated on an as needed basis. As a result the frequency provided may not always ensure users update as soon as new data is available. The frequency will also not guarantee that that when updates are done that the retrieved data is new. Still, the suggested refresh frequency will help well mannered users know what the provider believes is a reasonable time between repeated accesses of the system (R2.1.14).

4.2. <source> Element

The <source> Element {dw:sourceType} [?] holds information about the product’s source and links to credit and disclaimer information.

4.2.1. <more-information> Element

The <more-information> element {xsd:anyURI} is a link to the web page of the forecast’s source or a more complete forecast (R2.1.13).

4.2.2. <production-center> Element

The <production-center> element {xsd:production-centerType} [?] identifies which organization creates the product (R2.1.7).

4.2.2.1. <sub-center> Element

The <sub-center> element {xsd:string} [?] is the part of the production center that prepared the product (R2.1.8).

4.2.3. <disclaimer> Element

The <disclaimer> element {xsd:anyURI} [?] is the URL containing a disclaimer regarding the data (R2.1.9).

4.2.4. <credit> Element

The <credit> Element {xsd:anyURI} [?] is the URL used to credit the source of the data (R2.1.10).

4.2.5. <credit-logo> Element

The <credit-logo> element {xsd:anyURI} [?] is the image link used with the credit URL to acknowledge the data source (R.2.11).

4.2.6. <feedback> Element

The <feedback> Element {xsd:anyURI} [?] is a URL to a web page used to provide the production center comments on the product (R2.1.12).

5. DWML Data Elements

These elements hold the environmental data. They are children of the <data> element.(R2.2).

5.1. <location> Element

The <location> element {dw:locationType} [+]: Defines the location for the data contained in the element <data>. The element must contain exactly one of its child elements (R2.2.2).

5.1.1. <location-key> Element

The <location-key> element {dw:location-keyType} [?] is used to relate the location to its corresponding parameters (R2.2.2).

5.1.2. <point> Element

For information on the <point> element see Section 7.1

5.1.2.1. *summarization* Attribute

For information on the *summarization* attribute see Section 7.3.

5.1.3. <city> Element

The <city> element {dw:cityType} [?] contains the city name for which the data is valid (R2.2.2).

5.1.3.1. *state* Attribute

The *state* attribute {dw:stateType} holds the two digit abbreviation for the state that the city resides in (R2.2.2).

5.1.3.2. *summarization* Attribute

For information on the *summarization* attribute see Section 7.3.

5.1.4. <nws-zone> Element

The <nws-zone> element {dw:nws-zoneType} [?] contains the National Weather Service forecast zone name for which the data is valid (R2.2.2).

5.1.4.1. *state* Attribute

The *state* attribute {dw:stateType} holds the two digit abbreviation for the state that the city resides in (R2.2.2).

5.1.4.2. *summarization* Attribute

For information on the *summarization* attribute see Section 7.3.

5.1.5. <area> Element

The <area> element {dw:areaType} [?] is a geometrical shape may be used to define which grid points the data represents. The element must contain exactly one of its child elements (Derived from R2.2.1.5).

5.1.5.1. *area-type* Attribute

The *area-type* attribute {dw:area-typeType} defines the aerial shape being used. Permissible values include “circle” and “rectangle” (Derived from R2.2.1.5).

5.1.5.2. <circle> Element

The <circle> element {dw:circleType} [?] is a circular area about a grid point. The area can contain any number of grid points which are summarized.

5.1.6. <point> Element

For information on the <point> element see Section 7.1

5.1.6.1.1. <radius> Element

The <radius> element {dw:radiusType} is the distance from the center point of the circle to edge of the circular area (Derived from R2.2.1.5).

5.1.6.1.1.1. *radius-units* Attribute

The *radius-units* attribute {dw:radius-unitsType} is the units of the radius measurement. Example values include “statute miles” and “kilometers” (Derived from R2.2.1.5).

5.1.6.2. *summarization* Attribute

For information on the *summarization* attribute see Section 7.3.

5.1.6.3. <rectangle> Element

The <rectangle> element {dw:rectangleType} [?] is a rectangular area which is defined by four latitude and longitude pairs. The area can contain any number of grid points which are summarized.

5.1.7. <point> Element

For information on the <point> element see Section 7.1

5.1.8. <point> Element

For information on the <point> element see Section 7.1

5.1.9. <point> Element

For information on the <point> element see Section 7.1

5.1.10. <point> Element

For information on the <point> element see Section 7.1

5.1.10.1. *summarization* Attribute

For information on the *summarization* attribute see Section 7.3.

5.1.11. <height> Element

The <height> element {dw:heightType} [?] is the data point's distance above/below some datum. If this element is not present, it is assumed that the data values are surface based (R2.2.2.3.1).

5.1.11.1. *datum* Attribute

The *datum* attribute {dw:datumType} is the reference for the height measurement. Example values include "surface" and "mean sea level" (R2.2.2.3.1.1).

5.1.11.2. *height-units* Attribute

The *height-units* attribute {dw:unitsType} represents the units of measure used for the height value. Example values include "feet" and "meters" (R2.2.2.3.1.2).

5.1.12. <level> Element

The <level> element {dw:levelType} [?] allows the data to be valid at some specific level. For example, within model data, a value may apply to a sigma level (R2.2.2.3.2).

5.1.12.1. *vertical-coordinate* Attribute

For information on the *vertical-coordinate* attribute see Section 7.2.

5.1.13. <layer> Element

The <layer> element {dw:layerType} [?] allows the data to be valid for some specific layer. For example, within model data, a value may be valid through a sigma layer (R2.2.2.3.3).

5.1.13.1. *vertical-coordinate* Attribute

For information on the *vertical-coordinate* attribute see Section 7.2.

5.2. <moreWeatherInformation> Element

The <moreWeatherInformation> element {xsd:anyURI} contains a link to the NDFD point-and-click forecast page for each set of user requested lat/lon pairs.

5.2.1. *applicable-location* Attribute

The *applicable-location* attribute {dw:applicable-locationType} [?] is used to relate the location to a particular list of parameters (R2.2.1). In this case it is the user requested point number.

5.3. <time-layout> Element

The <time-layout> element {dw:time-layoutType} [+] contains the start and stop valid times and any associated period names for the data. Since different environmental parameters have different time schemes (valid at different interval and available for different lengths of time into the future), there will be one <time-layout> element for each of these unique temporal configurations. Each data parameter will reference exactly one of these time layouts (R2.2.3).

5.3.1. *time-coordinate* Attribute

The *time-coordinate* attribute {dw:time-coordinateType} defines the time coordinate as either “local time” or “UTC” (R2.2.3.3).

5.3.1.1. *summarization* Attribute

For information on the *summarization* attribute see Section 7.3.

5.3.2. <layout-key> Element

The <layout-key> element {dw:layout-keyType} contains the key (**k-p24h-n7-1**) used to associated this time layout with a particular parameter element (R2.2.3). The key is derived using the following convention:

- 1) “**k**” stands for key.
- 2) “**p24h**” implies a data period length of 24 hours.
- 3) “**n7**” means that the number of data times is 7.

- 4) “1” is a sequential number used to keep the layout keys unique.

The key **should not** be parsed to derive the period. This is because, the period length changes for some data type after day 3 and so period length implied by the key name only applies to the early times.

5.3.3. <start-valid-time> Element

The <start-valid-time> element {dw:start-valid-timeType} [+] is the start time of the period of time for which the data is valid (R2.2.3.1).

5.3.3.1.1. *period-name* Attribute

The *period-name* attribute {xsd:string} [?] contains the name associated with this time interval (ex. TODAY) (R2.2.3.4).

5.3.4. <end-valid-time> Element

The <end-valid-time> element {xsd:dateTime} [*]: The end time of the period of time for which the data is valid. The absence of this attribute indicates that the element is valid at a specific time (R2.2.3.2).

5.4. <parameters> Element

The <parameters> element {dw:parametersType} [+] holds the environmental data (R2.2.1).

5.4.1. *applicable-location* Attribute

The *applicable-location* attribute {dw:applicable-locationType} [?] is used to relate the location to a particular list of parameters (R2.2.1).

5.4.2. <temperature> Element

The <temperature> Element {dw:temperatureType} [*] is a container for temperature data (R2.2.1).

5.4.2.1. *type* Attribute

The *type* Attribute {dw:typeType} specifies the type of temperature. Example values include “maximum”, “minimum”, “temperature”, “dew point”, “heat index”, “wind chill” (R2.2.1.1).

5.4.2.2. *units* Attribute

The *units* attribute {dw:unitsType} defines the units of the temperature value. Example values include “F”, “C”, and “K”. The default value is “F” (R2.2.1.3).

5.4.2.3. *time-layout* Attribute

For information on the *time-layout* attribute see Section 7.4.

5.4.2.4. <value> Element

The <value> element {dw:valueType} [+]: The temperature value reported to the nearest whole degree. Missing values are represented by an empty element and xsi:nil="true" (R2.2.1).

5.4.2.4.1. *upper-range* Attribute

The *upper-range* attribute {dw:upper-rangeType} [?] holds the value associated with the upper end of a temperature range (R2.2.1).

5.4.2.4.2. *lower-range* Attribute

The *lower-range* attribute {dw:lower-rangeType} [?] holds the value associated with the lower end of a temperature range (R2.2.1).

5.4.2.5. <valueWithUncertainty> Element

The <valueWithUncertainty> element {dw: valueWithUncertaintyType} [+]: Element containing a <value> element and an <uncertainty> element. Represents a value like 75°F + or minus 1.5°F. Missing values are represented by an empty element and xsi:nil="true" (R2.2.1).

5.4.2.5.1. <value> Element

The <value> element {dw:valueType} [+]: The temperature value reported to the nearest whole degree. Missing values are represented by an empty element and xsi:nil="true" (R2.2.1).

5.4.2.5.1.1. *upper-range* Attribute

The *upper-range* attribute {dw:upper-rangeType} [?] holds the value associated with the upper end of a temperature range (R2.2.1).

5.4.2.5.1.2. *lower-range* Attribute

The *lower-range* attribute {dw:lower-rangeType} [?] holds the value associated with the lower end of a temperature range (R2.2.1).

5.4.2.5.2. <uncertainty> Element

Specifies the uncertainty {dw: uncertaintyType} [+] associated with the accompanying value.

5.4.2.5.2.1. *type* Attribute

The *type* Attribute {dw:uncertaintyTypeType} specifies the type of uncertainty. Example values include "analysis error" (R2.2.1.1).

5.4.2.5.2.2. <error> Element

The <error> element {errorType} [?] holds an uncertainty value characterized as an error.

5.4.2.5.2.1. *qualifier* Attribute

The *qualifier* attribute {dw:qualifierType} [?] is used to indicate how the error is applied. For example, a *qualifier* set to a value of “+/-”, indicating the error is to be added and subtracted from the base value to determine the range of values.

5.4.2.6. <name> Element

The <name> element {xsd:string} [?]: The name of this parameter. The name value can be used for display purposes (R2.2.1.2).

5.4.2.7. *categorical-table* Attribute

The *categorical-table* attribute {dw:categorical-tableType} [?] is the foreign key to a list of categories that define the meaning of the value (R2.2.1).

5.4.2.8. *conversion-table* Attribute

The *conversion-table* attribute {dw:conversion-tableType} [?] is the foreign key to a list of conversion tables that provide an equivalent value for the data (R2.2.1).

5.4.3. <precipitation> Element

The <precipitation> element {dw:precipitationType} [*] is a container for the precipitation values (R2.2.1).

5.4.3.1. *type* Attribute

The *type* Attribute {dw:typeType} specifies the type of precipitation parameter. Example values include “liquid” and “snow” (R2.2.1.1).

5.4.3.2. *units* Attribute

The *units* attribute {dw:unitsType} defines the units of the precipitation value. Example values include “inches” and “millimeters”. The default value is “inches” (R2.2.1.3).

5.4.3.3. *time-layout* Attribute

For information on the *time-layout* attribute see Section 7.4.

5.4.3.4. <value> Element

The <value> element {dw:valueType} [+]: The precipitation type parameter’s value to the nearest integer value. Missing values are represented by an empty element and xsi:nil=”true” (R2.2.1).

5.4.3.4.1. *upper-range* Attribute

The *upper-range* attribute {dw:upper-rangeType} [?] holds the value associated with the upper end of a precipitation range (R2.2.1).

5.4.3.4.2. *lower-range* Attribute

The *lower-range* attribute {dw:lower-rangeType} [?] holds the value associated with the lower end of a precipitation range (R2.2.1).

5.4.3.5. <name> Element

The <name> element {xsd:string} [?] is the name of this parameter. The name value can be used for display purposes (R2.2.1.2).

5.4.3.6. *categorical-table* Attribute

The *categorical-table* attribute {dw:categorical-tableType} [?] is the foreign key to a list of categories that define the meaning of the value (R2.2.1).

5.4.3.7. *conversion-table* Attribute

The *conversion-table* attribute {dw:conversion-tableType} [?] is the foreign key to a list of conversions tables that provide a equivalent value for the data (R2.2.1).

5.4.4. <probability-of-precipitation> Element

The <probability-of-precipitation> element {dw:probability-of-precipitationType} [*] is a container for the probability of precipitation (POP) values (R2.2.1).

5.4.4.1. *type* Attribute

The *type* Attribute {dw:typeType} specifies the type of POP parameter. Example values include “12 hour” and “floating”. Default value is “12 hour” (R2.2.1.1).

5.4.4.2. *units* Attribute

The *units* attribute {dw:unitsType} defines the units of the POP value. Example values include “percent” (R2.2.1.3).

5.4.4.3. *time-layout* Attribute

For information on the *time-layout* attribute see Section 7.4.

5.4.4.4. <value> Element

The <value> element {dw:valueType} [+]: The POP value to the nearest integer value. Missing values are represented by an empty element and xsi:nil=”true” (R2.2.1).

5.4.4.4.1. *upper-range* Attribute

The *upper-range* attribute {dw:upper-rangeType} [?] holds the value associated with the upper end of a probability of POP range (R2.2.1).

5.4.4.4.2. *lower-range* Attribute

The *lower-range* attribute {dw:lower-rangeType} [?] holds the value associated with the lower end of a POP range (R2.2.1).

5.4.4.5. <name> Element

The <name> element {xsd:string} [?] is the name of this parameter. The name value can be used for display purposes (R2.2.1.2).

5.4.4.6. *categorical-table* Attribute

The *categorical-table* attribute {dw:categorical-tableType} [?] is the foreign key to a list of categories that define the meaning of the value (R2.2.1).

5.4.4.7. *conversion-table* Attribute

The *conversion-table* attribute {dw:conversion-tableType} [?] is the foreign key to a list of conversions tables that provide a equivalent value for the data (R2.2.1).

5.4.5. <convective-hazard> Element

The <convective-hazard> element {dw:convective-hazardType} [*] is a container for the convective hazard values like hazard outlook, tornadoes, hail, severe thunderstorms from the Storm Prediction Center (R2.2.1).

5.4.5.1. *type* Attribute

The *type* Attribute {dw:typeType} specifies the type of convective hazard parameter. Example values include “outlook”, “tornadoes”, “hail”, “damaging thunderstorm wind” “extreme tornadoes”, “extreme hail”, “extreme thunderstorm winds”, “severe thunderstorms” and “extreme severe thunderstorms”. (R2.2.1.1).

5.4.5.2. *units* Attribute

The *units* attribute {dw:unitsType} defines the units of the convective hazard value. Example values include “percent” (R2.2.1.3).

5.4.5.3. *time-layout* Attribute

For information on the *time-layout* attribute see Section 7.4.

5.4.5.4. <value> Element

The <value> element {dw:valueType} [+]: The convective hazard value to the nearest integer value. Missing values are represented by an empty element and xsi:nil=”true” (R2.2.1).

5.4.5.4.1. *upper-range* Attribute

The *upper-range* attribute {dw:upper-rangeType} [?] holds the value associated with the upper end of a probability of convective hazard range (R2.2.1).

5.4.5.4.2. *lower-range* Attribute

The *lower-range* attribute {dw:lower-rangeType} [?] holds the value associated with the lower end of a convective hazard range (R2.2.1).

5.4.5.5. <name> Element

The <name> element {xsd:string} [?] is the name of this parameter. The name value can be used for display purposes (R2.2.1.2).

5.4.5.6. *categorical-table* Attribute

The *categorical-table* attribute {dw:categorical-tableType} [?] is the foreign key to a list of categories that define the meaning of the value (R2.2.1).

5.4.5.7. *conversion-table* Attribute

The *conversion-table* attribute {dw:conversion-tableType} [?] is the foreign key to a list of conversions tables that provide a equivalent value for the data (R2.2.1).

5.4.6. <wind-speed> Element

The <wind-speed> element {dw:wind-speedType} [*] is a container for the wind speed values (R2.2.1).

5.4.6.1. *type* Attribute

The *type* Attribute {dw:typeType} specifies the type of wind speed parameter. Example values include “sustained”, “cumulative34”, and “gust” (R2.2.1.1).

5.4.6.2. *units* Attribute

The *units* attribute {dw:unitsType} defines the units of the wind speed values. Example values include “knots”, “meters per second”, and “percent”. The default value is “knots”. NOTE: “percent” is used for probabilistic winds (R2.2.1.3).

5.4.6.3. *time-layout* Attribute

For information on the *time-layout* attribute see Section 7.4.

5.4.6.4. <value> Element

The <value> element {dw:valueType} [+]: The wind speed value reported to the nearest integer. Missing values are represented by an empty element and xsi:nil=”true” (R2.2.1).

5.4.6.4.1. *upper-range* Attribute

The *upper-range* attribute {dw:upper-rangeType} [?] holds the value associated with the upper end of a wind speed range (R2.2.1).

5.4.6.4.2. *lower-range* Attribute

The *lower-range* attribute {dw:lower-rangeType} [?] holds the value associated with the lower end of a temperature range (R2.2.1).

5.4.6.5. <valueWithUncertainty> Element

The <valueWithUncertainty> element {dw: valueWithUncertaintyType} [+]: Element containing a <value> element and an <uncertainty> element. Represents a value like 10 kts + or minus 2.0 kts. Missing values are represented by an empty element and xsi:nil="true" (R2.2.1).

5.4.6.5.1. <value> Element

The <value> element {dw:valueType} [+]: The temperature value reported to the nearest whole degree. Missing values are represented by an empty element and xsi:nil="true" (R2.2.1).

5.4.6.5.1.1. *upper-range* Attribute

The *upper-range* attribute {dw:upper-rangeType} [?] holds the value associated with the upper end of a temperature range (R2.2.1).

5.4.6.5.1.2. *lower-range* Attribute

The *lower-range* attribute {dw:lower-rangeType} [?] holds the value associated with the lower end of a temperature range (R2.2.1).

5.4.6.5.2. <uncertainty> Element

Specifies the uncertainty {dw: uncertaintyType} [+] associated with the accompanying value.

5.4.6.5.2.1. *type* Attribute

The *type* Attribute {dw:uncertaintyTypeType} specifies the type of uncertainty. Example values include "analysis error" (R2.2.1.1).

5.4.6.5.2.2. <error> Element

The <error> element {errorType} [?] holds an uncertainty value characterized as an error.

5.4.6.5.2.2.1. *qualifier* Attribute

5.4.6.5.3. The *qualifier* attribute {dw:qualifierType} [?] is use to indicate how the error is applied. For example, a *qualifier* set to a value of "+/-", indicating the error is to be added and subtracted from the base value to determine the range of values.

5.4.6.6. <name> Element

The <name> element {xsd:string} [?] is the name of this parameter. The name value can be used for display purposes (R2.2.1.2).

5.4.6.7. *categorical-table* Attribute

The *categorical-table* attribute {dw:categorical-tableType} [?] is the foreign key to a list of categories that define the meaning of the value (R2.2.1).

5.4.6.8. *conversion-table* Attribute

The *conversion-table* attribute {dw:conversion-tableType} [?] is the foreign key to a list of conversions tables that provide a equivalent value for the data (R2.2.1).

5.4.7. <direction> Element

The <direction> element {dw:directionType} [?] is a container for the direction values (R2.2.1).

5.4.7.1. *type* Attribute

The *type* Attribute {dw:typeType} specifies the type of wind direction. Example values include “wind” and “swell”. The default value is “wind” (R2.2.1.1).

5.4.7.2. *units* Attribute

The *units* attribute {dw:unitsType} defines the units of the wind direction values. Example values include “degrees true” (R2.2.1.3).

5.4.7.3. *time-layout* Attribute

For information on the *time-layout* attribute see Section 7.4.

5.4.7.4. <value> Element

The <value> element {dw:valueType} [+]: The wind direction value reported to the nearest integer. Missing values are represented by an empty element and xsi:nil=”true” (R2.2.1).

5.4.7.4.1. *upper-range* Attribute

The *upper-range* attribute {dw:upper-rangeType} [?] holds the value associated with the upper end of a wind direction range (R2.2.1).

5.4.7.4.2. *lower-range* Attribute

The *lower-range* attribute {dw:lower-rangeType} [?] holds the value associated with the lower end of a wind direction range (R2.2.1).

5.4.7.5. <valueWithUncertainty> Element

The <valueWithUncertainty> element {dw:valueWithUncertaintyType} [+]: Element containing a <value> element and an <uncertainty> element. Represents a value like 270° + or minus 5.0°. Missing values are represented by an empty element and xsi:nil="true" (R2.2.1).

5.4.7.5.1. <value> Element

The <value> element {dw:valueType} [+]: The temperature value reported to the nearest whole degree. Missing values are represented by an empty element and xsi:nil="true" (R2.2.1).

5.4.7.5.1.1. *upper-range* Attribute

The *upper-range* attribute {dw:upper-rangeType} [?] holds the value associated with the upper end of a temperature range (R2.2.1).

5.4.7.5.1.2. *lower-range* Attribute

The *lower-range* attribute {dw:lower-rangeType} [?] holds the value associated with the lower end of a temperature range (R2.2.1).

5.4.7.5.2. <uncertainty> Element

Specifies the uncertainty {dw:uncertaintyType} [+] associated with the accompanying value.

5.4.7.5.2.1. *type* Attribute

The *type* Attribute {dw:uncertaintyTypeType} specifies the type of uncertainty. Example values include "analysis error" (R2.2.1.1).

5.4.7.5.2.2. <error> Element

The <error> element {errorType} [?] holds an uncertainty value characterized as an error.

5.4.7.5.2.2.1. *qualifier* Attribute

5.4.7.5.3. The *qualifier* attribute {dw:qualifierType} [?] is use to indicate how the error is applied. For example, a *qualifier* set to a value of "+/-", indicating the error is to be added and subtracted from the base value to determine the range of values.

5.4.7.6. <name> Element

The <name> element {xsd:string} [?] is the name of this parameter. The name value can be used for display purposes (R2.2.1.2).

5.4.7.7. *categorical-table* Attribute

The *categorical-table* attribute {dw:categorical-tableType} [?] is the foreign key to a list of categories that define the meaning of the value (R2.2.1).

5.4.7.8. *conversion-table* Attribute

The *conversion-table* attribute {dw:conversion-tableType} [?] is the foreign key to a list of conversions tables that provide a equivalent value for the data (R2.2.1).

5.4.8. <cloud-amount> Element

The <cloud-amount> element {dw:cloud-amountType} [*] is a container for the cloud amount values (R2.2.1).

5.4.8.1. *type* Attribute

The *type* Attribute {dw:typeType} specifies the type of cloud amount values. Example values include “total” and “layered” (R2.2.1.1).

5.4.8.2. *units* Attribute

The *units* attribute {dw:unitsType} defines the units of the cloud amount values. Example values include “percent” and “8ths”. The default value is “percent” (R2.2.1.3).

5.4.8.3. *time-layout* Attribute

For information on the *time-layout* attribute see Section 7.4.

5.4.8.4. <value> Element

The <value> element {dw:valueType} [+]: The cloud cover value reported to the nearest integer. Missing values are represented by an empty element and xsi:nil=”true” (R2.2.1).

5.4.8.4.1. *upper-range* Attribute

The *upper-range* attribute {dw:upper-rangeType} [?] holds the value associated with the upper end of a range of cloud amount (R2.2.1).

5.4.8.4.2. *lower-range* Attribute

The *lower-range* attribute {dw:lower-rangeType} [?] holds the value associated with the lower end of a range of cloud amount (R2.2.1).

5.4.8.5. <name> Element

The <name> element {xsd:string} [?] is the name of this parameter. The name value can be used for display purposes (R2.2.1.2).

5.4.8.6. <cloud-layer> Element

The <cloud-layer> element {dw:layerType} [?] is the layer containing the cloud amount. Example values include “high”, “middle”, and “low”. This element is not present when the type attribute is set to “total” (Derived from R2.2.1).

5.4.8.7. *categorical-table* Attribute

The *categorical-table* attribute {dw:categorical-tableType} [?] is the foreign key to a list of categories that define the meaning of the value (R2.2.1).

5.4.8.8. *conversion-table* Attribute

The *conversion-table* attribute {dw:conversion-tableType} [?] is the foreign key to a list of conversions tables that provide a equivalent value for the data (R2.2.1).

5.4.9. <weather> Element

The <weather> element {dw:weatherType} [?] is a container for the weather values (R2.2.1).

5.4.9.1. *time-layout* Attribute

For information on the *time-layout* attribute see Section 7.4.

5.4.9.2. <weather-conditions> Element

The <weather-conditions> element {weather-conditionsType} [+] is a container for up to three weather values that are used to describe the weather conditions at a given time. Missing values are represented by an empty element and xsi:nil="true" (R2.2.1).

5.4.9.3. <value> Element

The <value> element {dw:valueType} [* (max of 5)] hold the sensible weather information. Missing values are represented by an empty element and xsi:nil="true" (R2.2.1).

5.4.9.3.1.1. *coverage* Attribute

The *coverage* attribute {dw:coverageType} [?] holds the weather coverage value. Valid values for the NDFD are contained in Appendix E, Table 3 (R2.2.1).

5.4.9.3.1.2. *intensity* Attribute

The *intensity* attribute {dw:intensityType} [?] holds the weather intensity. Valid values for the NDFD are contained in Appendix E, Table 4 (R2.2.1).

5.4.9.3.1.3. *additive* Attribute

The *additive* attribute {dw:additiveType} [?] dictates whether the following value element is combined using an “and” or an “or”. For example rain and snow vice rain or snow (R2.2.1).

5.4.9.3.1.4. *qualifier* Attribute

The *qualifier* attribute {dw:qualifierType} [?] is used to communicate a special aspect of the weather value. Valid values for the NDFD are contained in Appendix E, Table 6 (R2.2.1).

5.4.9.3.1.5. *weather-type* Attribute

The *weather-type* attribute {dw:weather-typeType} [?] captures the weather element being forecast. Valid values for the NDFD are contained in Appendix E, Table 5 (R2.2.1).

5.4.9.3.1.6. <visibility> Element

The <visibility> element {dw:visibilityType} [*] contains the weather visibility value (R2.2.1).

5.4.9.3.1.6.1. *units* Attribute

The *units* attribute {dw:unitsType} contains the units of the visibility value. Example values include “statute miles” and “meters” (R2.2.1).

5.4.9.4. *categorical-table* Attribute

The *categorical-table* attribute {dw:categorical-tableType} [?] is the foreign key to a list of categories that define the meaning of the value (R2.2.1).

5.4.9.5. *conversion-table* Attribute

The *conversion-table* attribute {dw:conversion-tableType} [?] is the foreign key to a list of conversions tables that provide a equivalent value for the data (R2.2.1).

5.4.9.6. *weather-summary* Attribute

The *weather-summary* Attribute {xsd:string} [?] is a short phrase (~2 words) used to summarize the weather conditions for that time. Example phrases include “partly cloudy” and “scattered thunderstorms” (R2.2.1).

5.4.10. <humidity> Element

The <humidity> Element {dw:humidityType} [?] is a container for humidity values (R2.2.1).

5.4.10.1. *type* Attribute

The *type* Attribute {dw:typeType} specifies the type of humidity. Example values include “relative” and “specific” (R2.2.1.1).

5.4.10.2. *units* Attribute

The *units* attribute {dw:unitsType} defines the units of the humidity values. Example values include “percent” and “kilogram/kilogram” (R2.2.1.3).

5.4.10.3. *time-layout* Attribute

For information on the *time-layout* attribute see Section 7.4.

5.4.10.4. <value> Element

The <value> element {dw:valueType} [+]: The humidity value reported to the nearest integer. Missing values are represented by an empty element and xsi:nil="true" (R2.2.1).

5.4.10.4.1. *upper-range* Attribute

The *upper-range* attribute {dw:upper-rangeType} [?] holds the value associated with the upper end of a relative humidity range (R2.2.1).

5.4.10.4.2. *lower-range* Attribute

The *lower-range* attribute {dw:lower-rangeType} [?] holds the value associated with the lower end of a relative humidity range (R2.2.1).

5.4.10.5. <name> Element

The <name> element {xsd:string} [?] is the name of this parameter. The name value can be used for display purposes (R2.2.1.2).

5.4.10.6. *categorical-table* Attribute

The *categorical-table* attribute {dw:categorical-tableType} [?] is the foreign key to a list of categories that define the meaning of the value (R2.2.1).

5.4.10.7. *conversion-table* Attribute

The *conversion-table* attribute {dw:conversion-tableType} [?] is the foreign key to a list of conversions tables that provide a equivalent value for the data (R2.2.1).

5.4.11. <conditions-icons> Element

The <conditions-icons> element {dw:conditions-iconsType} [?] holds a URL for a weather icon depicting the cloud and precipitation conditions. The icons will be consistent with other NWS forecast products (R5.1).

5.4.11.1. *type* Attribute

The *type* Attribute {dw:typeType} specifies the type of icons. Example values include "forecast-NWS" (R2.2.1.1).

5.4.11.2. *time-layout* Attribute

For information on the *time-layout* attribute see Section 7.4.

5.4.11.3. <name> Element

The <name> element {xsd:string} [?] is the name of this parameter. The name value can be used for display purposes (R2.2.1.2).

5.4.11.4. <icon-link> Element

The <icon-link> element {xsd:anyURI} [+] contains the URL of the icon used to represent weather conditions (R5.1).

NOTE: The priority algorithm for icon determination can be found in Table 8–Table 11. In these tables, the nomenclature [20,30...90,100] indicates that one of the 2 digit values appear in the icon file name. For example, the rain icon could be ra20.jpg, ra30.jpg on up to ra100.jpg.

5.4.12. <wordedForecast> Element

The <wordedForecast> element {dw:wordedForecastType} [?] holds a text representation of the forecast for the indicated time period.

5.4.12.1. *time-layout* Attribute

For information on the *time-layout* attribute see Section 7.4.

5.4.12.2. *dataSource*

Describes the data source used to create the worded forecast (examples include “NDFD Mosaic” or “Local NetCDF”, etc.).

5.4.12.3. *wordGenerator*

Specifies which algorithm was used to create the worded forecast (examples include “MarkMitchell”).

5.4.12.4. <name> Element

The <name> element {xsd:string} [?] is the name of this parameter. The name value can be used for display purposes (R2.2.1.2).

5.4.12.5. <text> Element

The <text> element {dw:textType} [+]: The worded forecast. Missing entries are represented by an empty element and xsi:nil=”true” (R2.2.1).

5.4.13. <water-state> Element

The <water-state> Element {dw:water-stateType} [?] is a container for sea and wave information. The seas element will not be present when the waves or swell elements are used. The wave and swell can both appear or they may appear separately (R2.2.1).

5.4.13.1. *time-layout* Attribute

For information on the *time-layout* attribute see Section 7.4.

5.4.13.2. <seas> Element

The <seas> element {dw:seasType} [?] holds the height of the seas which is a combination of both wind waves and swell (R2.2.1).

5.4.13.3. *type* Attribute

The *type* Attribute {dw:typeType} specifies the type of seas. An example value includes “combined” (R2.2.1.1).

5.4.13.4. *units* Attribute

The *units* attribute {dw:unitsType} defines the units of the seas values. Example values include “feet” and “meters” (R2.2.1.3).

5.4.13.5. <value> Element

The <value> element {dw:valueType} [+]: The seas value reported to the nearest integer. Missing values are represented by an empty element and xsi:nil=”true” (R2.2.1).

5.4.13.5.1. *upper-range* Attribute

The *upper-range* attribute {dw:upper-rangeType} [?] holds the value associated with the upper end of a sea height range (R2.2.1).

5.4.13.5.2. *lower-range* Attribute

The *lower-range* attribute {dw:lower-rangeType} [?] holds the value associated with the lower end of a sea height range (R2.2.1).

5.4.13.6. <name> Element

The <name> element {xsd:string} [?] is the name of this parameter. The name value can be used for display purposes (R2.2.1.2).

5.4.13.7. <waves> Element

The <waves> element {dw:wavesType} [?] holds the height of waves generated by the local wind blowing (R2.2.1).

5.4.13.8. *type* Attribute

The *type* Attribute {dw:typeType} specifies the type of waves. An example value includes “wind” or “significant” (R2.2.1.1).

5.4.13.9. *units* Attribute

The *units* attribute {dw:unitsType} defines the units of the wave values. Example values include “feet” and “meters” (R2.2.1.3).

5.4.13.10. <value> Element

The <value> element {dw:valueType} [+]: The wave value reported to the nearest integer. Missing values are represented by an empty element and xsi:nil="true" (R2.2.1).

5.4.13.10.1. *upper-range* Attribute

The *upper-range* attribute {dw:upper-rangeType} [?] holds the value associated with the upper end of a wave height range (R2.2.1).

5.4.13.10.2. *lower-range* Attribute

The *lower-range* attribute {dw:lower-rangeType} [?] holds the value associated with the lower end of a wave height range (R2.2.1).

5.4.13.10.2.1. *period* Attribute

The *period* attribute {xsd:nonNegativeIntegers} [?] holds the time, in seconds for the passage of successive wave crests (R2.2.1).

5.4.13.10.2.2. *steepness* Attribute

The *steepness* attribute {xsd:nonNegativeIntegers} [?] holds the Ratio of wave height to wavelength. Theoretical wave steepness maximum is around 1/10, after which the wave becomes unstable and breaks (R2.2.1).

5.4.13.11. <name> Element

The <name> element {xsd:string} [?] is the name of this parameter. The name value can be used for display purposes (R2.2.1.2).

5.4.13.12. <swell> Element

The <swell> element {dw:swellType} [?] holds the height of wind waves which have traveled beyond the wave generation region (R2.2.1).

5.4.13.13. *type* Attribute

The *type* Attribute {dw:typeType} specifies the type of swell. An example value includes "significant" (R2.2.1.1).

5.4.13.14. *units* Attribute

The *units* attribute {dw:unitsType} defines the units of the swell values. Example values include "feet" and "meters" (R2.2.1.3).

5.4.13.15. <value> Element

The <value> element {dw:valueType} [+] contains the swell value reported to the nearest integer. Missing values are represented by an empty element and xsi:nil="true" (R2.2.1).

5.4.13.15.1. *upper-range* Attribute

The *upper-range* attribute {dw:upper-rangeType} [?] holds the value associated with the upper end of a swell height range (R2.2.1).

5.4.13.15.2. *lower-range* Attribute

The *lower-range* attribute {dw:lower-rangeType} [?] holds the value associated with the lower end of a swell height range (R2.2.1).

5.4.13.15.2.1. *period* Attribute

The *period* attribute {xsd:nonNegativeIntegers} [?] holds the time, in seconds for the passage of successive wave crests (R2.2.1).

5.4.13.15.2.2. *steepness* Attribute

The *steepness* attribute {xsd:nonNegativeIntegers} [?] holds the Ratio of wave height to wavelength. Theoretical wave steepness maximum is around 1/10, after which the wave becomes unstable and breaks (R2.2.1).

5.4.13.16. <name> Element

The <name> element {xsd:string} [?] is the name of this parameter. The name value can be used for display purposes (R2.2.1.2).

5.4.13.16.1. <direction> Element

The <direction> element {dw:directionType} [+] is a container for the direction values (R2.2.1).

5.4.13.17. *type* Attribute

The *type* Attribute {dw:typeType} specifies the type of swell direction. Example values include “wind” and “swell”. The default value is “wind” (R2.2.1.1).

5.4.13.18. *units* Attribute

The *units* attribute {dw:unitsType} defines the units of the swell direction values. Example values include “degrees true” (R2.2.1.3).

5.4.13.19. <value> Element

The <value> element {dw:valueType} [+] holds the direction value reported to the nearest integer. Missing values are represented by an empty element and xsi:nil=”true” (R2.2.1).

5.4.13.19.1. *upper-range* Attribute

The *upper-range* attribute {dw:upper-rangeType} [?] holds the value associated with the upper end of a swell direction range (R2.2.1).

5.4.13.19.2. *lower-range* Attribute

The *lower-range* attribute {dw:lower-rangeType} [?] holds the value associated with the lower end of a swell direction range (R2.2.1).

5.4.13.20. <name> Element

The <name> element {xsd:string} [?] is the name of this parameter. The name value can be used for display purposes (R2.2.1.2).

5.4.13.21. *ice-coverage* Element

The *ice-coverage* element {dw:ice-coverageType} [?] holds the amount of ice on the water body (R2.2.1).

5.4.13.22. *type* Attribute

The *type* attribute {dw:typeType} specifies the type of ice coverage. An example value includes “total” (R2.2.1.1).

5.4.13.23. *units* Attribute

The *units* attribute {dw:unitsType} defines the units of the ice coverage values. Example values include “percent” (R2.2.1.3).

5.4.13.24. <value> Element

The <value> element {dw:valueType} [+]: The ice coverage value reported to the nearest integer. Missing values are represented by an empty element and xsi:nil=”true” (R2.2.1).

5.4.13.24.1. *upper-range* Attribute

The *upper-range* attribute {dw:upper-rangeType} [?] holds the value associated with the upper end of a ice coverage range (R2.2.1).

5.4.13.24.2. *lower-range* Attribute

The *lower-range* attribute {dw:lower-rangeType} [?] holds the value associated with the lower end of a ice coverage range (R2.2.1).

5.4.13.25. <name> Element

The <name> element {xsd:string} [?] is the name of this parameter. The name value can be used for display purposes (R2.2.1.2).

5.5. <categoryal-definitions> Element

The <categoryal-definitions> element {dw:categoryal-definitionsType} [?] contains the definitions of categories found in parameter value elements (R2.2.1).

5.5.1. <category-table> Element

The <category-table> element {dw:category-table-elementType} [+] contains the categorical data (R2.2.1).

5.5.1.1. *units* Attribute

5.5.1.2. The *units* attribute {dw:unitsType} defines the units of the data in the categories (R2.2.1).

5.5.1.3. <category-key> Element

The <category-key> element {dw:category-keyType} is the primary key relating the data in the parameter element to a particular categorical table (R2.2.1).

5.5.1.4. <value> Element

The <value> element {dw:valueType} [+]: The value found in the data (R2.2.1).

5.5.1.4.1. *category* {xsd:string}: The category corresponding to the value (R2.2.1).

5.6. <conversion-definitions> Element

The <conversion-definitions> element {dw:conversion-definitionsType} [?] contains look-up tables used to relate numerical data to an equivalent value (R2.2.1).

5.6.1. <conversion-table> Element

The <conversion-table> element {dw:conversion-table-elementType} [+] holds the range of data associated with each equivalent value (R2.2.1).

5.6.1.1. <conversion-key> Element

The <conversion-key> element {dw:conversion-keyType} contains the primary key relating the data in the parameter element to a particular conversion table (R2.2.1).

5.6.1.2. <start-value> Element

The <start-value> element {dw:start-valueType} [+] is the starting value of the range of data for which the value is equivalent (R2.2.1).

5.6.1.3. <end-value> Element

The <end-value> element {dw:end-valueType} [+] is the ending value of the range of data for which the value is equivalent (R2.2.1).

5.6.1.4. <equivalent-value> Element

The <equivalent-value> element {xsd:string} [+] is the equivalent value of the data (R2.2.1).

6. Latitude and Longitude Lists

6.1. <latLonList> Element

The <latLonList> element {dw:latLonListType} [?] holds a list of latitude and longitude pairs that are contained in a subgrid. A latitude and longitude pair is composed of a latitude value followed by a comma followed by a longitude value (i.e. 38.98,-77.07). Each latitude and longitude pair is separated by a space (i.e. 33.869922,-80.080906 33.914765,-80.074936).

7. Common Element and Attribute Definitions

7.1. <point> Element

The <point> element {dw:pointType} [?] is the element used to define the grid point for which the data is valid (R2.2.2).

7.1.1. *latitude* Attribute

The *latitude* attribute {xsd:decimal} defines the latitude of the point where the data is valid (R2.2.2.2).

7.1.2. *longitude* Attribute

The *longitude* attribute {xsd:decimal} defines the latitude of the point where the data is valid (R2.2.2.2).

7.2. *vertical-coordinate* Attribute

The *vertical-coordinate* attribute {xsd:string} defines the data's vertical position (R2.2.2.3).

7.3. *summarization* Attribute

The *summarization* attribute {dw:summarizationType} [?] indicates how a collection of grid point values is summarized into a single value. Example summarization types include “none”, “mean”, “median”, “mode”, “maximum”, “minimum”, “12hourly”, or “24hourly”. A value of “none” indicates that the values are valid at a single grid point or time (R2.2.1.5).

7.4. *time-layout* Attribute

The *time-layout* attribute {dw:time-layoutType} defines the key to the appropriate valid times and any relevant period name information (R2.2.3).

8. XML Considerations

8.1. Namespace

DWML will use the namespace <http://www.nws.noaa.gov/mdl/ndfd/dwml>.

8.2. Schema

DWML will use XML Schema to perform validity checking.

8.3. **Character Set**

DWML will use UTF-8 encoding.

Appendix A: DWML Requirements

1. Overview

This document defines the requirements for a markup language of the National Oceanic and Atmospheric Administration's National Weather Service's (NWS) National Digital Forecast Database (NDFD). This document will refer to the new markup language as the Digital Weather Markup Language (DWML). DWML will serve as a vehicle for transferring portions of the NDFD to NOAA's customers and partners. The piece of the database distributed in DWML will correspond to some subset of the available weather elements, times, and grid points. While DWML will initially focus on NDFD data, the intent is to make this new markup language flexible and scaleable enough to accommodate other meteorological data such as weather observations and guidance products.

1.1. **Message:** A collection of DWML elements in a valid arrangement.

1.2. **Product:** A collection of NWS information in a defined format.

1.3. **Issuance:** A particular product.

2. XML Components

DWML contains both metadata as well as meteorological data. The two will be clearly separated within a message.

2.1. **DWML Metadata:** DWML metadata will provide information about the DWML message and the data it contains. The metadata will provide the following some of which may be optional for a given issuer.

2.1.1. **Product Title:** A concise summarization of what this DWML product contains.

2.1.2. **Product Creation Date:** The date and time that the product was prepared.

2.1.3. **DWML Version:** Indicates which version of DWML is being used.

2.1.4. **Operational Mode:** The operational mode tells the user if the message is produced as a developmental, experimental or official product, or a test. See [National Weather Service Instruction 10-102](#) for additional details on changes in operational mode.

2.1.4.1. **Test:** Indicates that this is an instance of an existing DWML product that contains some change being evaluated by the DWML development team. Users will typically not process this product.

2.1.4.2. **Developmental:** A new product that is not yet ready for public evaluation or use.

- 2.1.4.3. **Experimental:** Product is available for testing and evaluation for a specified, limited time period for the explicit purpose of obtaining customer feedback.
- 2.1.4.4. **Official:** Operational products defined in NWS policy
- 2.1.5. **Product Class:** Product Class specifies the general type of product contained in a DWML instance. Expected values include meteorological, hydrological, oceanographical, land surface, and space.
- 2.1.6. **Product Type:** The product type defines the specific category of the product class to which the product belongs. Examples include observation, forecast, analysis, and statistic.
- 2.1.7. **Production Center:** Production Center identifies which organization creates the product.
- 2.1.8. **Product Sub-center:** The component of the product center that prepared the product.
- 2.1.9. **Disclaimer URL:** The URL containing an optional disclaimer that the production center wants users to know about.
- 2.1.10. **Credit URL:** The URL used to credit the source of the data.
- 2.1.11. **Credit Logo:** The optional image used with the credit URL to acknowledge the data source.
- 2.1.12. **Feedback URL:** The optional URL to a web page used to provide the production center comments on the product.
- 2.1.13. **Additional Information URL:** A link to a more complete forecast or the web page for the forecast's source.
- 2.1.14. **Suggested Refresh Frequency:** Used by the production center to help users know how often to return for updated data. Since the NDFD is updated on an as needed basis, the frequency provided will not always ensure users update as soon as new data is available. The frequency will also not guarantee that that when updates are done that the retrieved data is new. Still, the suggested refresh frequency will help well mannered users know what the provider believes is a reasonable time between repeated accesses of the system (i.e. seconds, days, months, etc).
- 2.2. **DWML Data:** At the heart of NDFD data is a meteorological value with a geographical and temporal component. To define this value, DWML needs to provide the following information:
 - 2.2.1. **Data Value:** This is the information retrieved or derived from the NDFD database (i.e. 71).

- 2.2.1.1. **Value Type:** The category to which the parameter belongs. For example, temperature is the category that contains maximum temperature, dew point temperature etc.
 - 2.2.1.2. **Value Name:** The name of the parameter that the value measures (i.e. maximum temperature).
 - 2.2.1.3. **Value Units:** The units of the parameter (i.e. °F).
 - 2.2.1.4. **Value Precision:** The value needs to be provided with the correct number of significant digits (i.e. 71 °F).
 - 2.2.1.5. **Type of Spatial Summarization:** Collections of grid point values may be summarized into a single value. If this is done, the type of summarization will be provided (mean, median, mode, centroid value etc.).
 - 2.2.1.6. **Type of Temporal Summarization:** A number of grid point values may be summarized for a given period of time. When this is done, the type of temporal summarization will be provided (period, hourly, 3 hourly, daily, etc.).
- 2.2.2. **Data Location:** The three dimensional place that the data value applies to.
- 2.2.2.1. **Type of Geography:** Types of geography could include a point (lat/lon), city and state, county, National Weather Service forecast zone, and zip code.
 - 2.2.2.2. **Horizontal Location:** The position of the data projected onto the earth's surface. This could be a latitude and longitude pair, a specific city and state, a county name, a National Weather Service zone name, or a zip code.
 - 2.2.2.3. **Vertical Coordinate System:** The type of coordinates that define the data's vertical position (i.e. height above mean sea level, sigma, etc.). Dependant on the vertical coordinate system, one of the following will also be needed.
 - 2.2.2.3.1. **Height:** This is the data point's distance above/below some datum.
 - 2.2.2.3.1.1. **Datum:** This is the reference for the height measurement (i.e. earth surface, mean sea level, etc.).
 - 2.2.2.3.1.2. **Units:** The units of measure used for the height value.
 - 2.2.2.3.2. **Level:** The digital data's vertical position may be defined at some discrete level.
 - 2.2.2.3.3. **Layer:** The digital data's vertical position may be defined for some discrete layer.
- 2.2.3. **Data Time:** DWML will provide for arbitrary time periods as well as common time references.

2.2.3.1. **Start of Valid Time:** The start time of the period for which the data is valid.

2.2.3.2. **End of Valid Time:** The end time of the period for which the data is valid.

2.2.3.3. **Time Coordinate:** Can be either Local Time (LT) or Coordinated Universal Time (UTC).

2.2.3.4. **Period Name:** A textual description of the time embodied by the start and end times. For example, the time might correspond to “THIS AFTERNOON”.

3. DWML Validation

3.1. DWML will adhere to the requirements defining well formed XML.

3.2. DWML will provide a schema to ensure any given instance conforms to the language’s specifications.

3.3. DWML will use UTF-8 encoding.

4. General Characteristics

4.1. DWML will use self describing element and attribute names.

4.2. DWML will employ industry standards to ensure the language is easy to maintain and is capable of later expansion.

5. Product Samples

DWML should be capable of producing XML versions of the following three existing National Weather Service’s web products.

5.1. Forecast at a Glance

The current experimental grid point forecast ([on-line example](#)) contains the high or low temperature, the sky condition, and a weather icon. Figure 1 shows an example of the experimental forecast product. See Table 1 for DWML sample metadata and data values for this product.

5.2. Digital Tabular Forecast

The current experimental forecast ([on-line example](#)) contains hourly values for temperature, dew point temperature, probability of precipitation, wind direction and speed, sky cover, as well as precipitation type information. Figure 2 shows an example of this experimental forecast product. See Table 1 for DWML sample metadata and data values for this product.

5.3. Digital Zone Forecast

This product is similar to the Forecast at a Glance in that it uses 12 hour forecast periods to summarize the NDFD data. The digital zone forecast is like the Digital Tabular Forecast in

terms of its use of an extensive number of weather elements. Figure 3 shows an example product. See Table 1 for sample DWML metadata and data values for this product.







This Afternoon	Tonight	Saturday	Saturday Night	Sunday	Sunday Night	Monday
						
Partly Cloudy	Partly Cloudy	Mostly Cloudy	Mostly Clear	Partly Cloudy	Partly Cloudy	Partly Cloudy
Hi 74 °F	Lo 58 °F	Hi 79 °F	Lo 55 °F	Hi 81 °F	Lo 59 °F	Hi 77 °F

Figure 1. Example Forecast at a Glance Product

Error! Not a valid link.

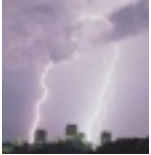
Figure 2. Example Digital/Tabular Forecast Product

	This Afternoon	Tonight	Saturday	Saturday Night	Sunday	Sunday Night
Sky Cover	30 %	25 %	20 %	35 %	60 %	65 %
High/Low	74 °F	58 °F	79 °F	55 °F	81 °F	59 °F
Wind Direction	NW	NW	SW	SW	SW	SE
Wind Speed	5 -10	5 -10	5 -10	5 -10	10 - 15	5 -10
PoP	0	0	0	0	40	60
Weather Type	None	None	None	None	Thunderstorms	Showers

Figure 3. Example Digital Zone Forecast Product

XML Data Item	Forecast at a Glance	Digital Tabular Forecast	Digital Zone Forecast
Title	Gridpoint Forecast at a Glance	Gridpoint Digital Tabular Forecast	Gridpoint Digital Zone Forecast
Creation Date/Time	2003-09-22T15:30:03Z		
Generator	DWML Version 1.0		
Operational Mode	Experimental		
Class	Meteorological		
Product Type	Forecast		
Product Center	Meteorological Development Laboratory (W/OST2)		
Sub-center	Product Generation Branch		
Disclaimer URL	http://www.nws.noaa.gov/disclaimer.html		
Credit URL	http://www.nws.noaa.gov/		
Credit Logo	http://www.nws.noaa.gov/images/noaaleft.jpg		
Feedback URL	http://www.nws.noaa.gov/mdl/		
Additional Info URL	http://www.crh.noaa.gov/ifps/MapClick.php?site=lwx&CiTemplate=1&FcstType=text&MapType=0&TempBox=1&DewBox=1&WindBox=1&ChillBox=1&SkyBox=1&SnowBox=1&FzgBox=1&SleetBox=1&map.x=187&map.y=60		
Refresh Frequency	Hourly		
Value Type	Icon	Temperature	Temperature
Value Name	Weather Icon	Temperature	Maximum Temperature
Value Units	None	°F	°F

XML Data Item	Forecast at a Glance	Digital Tabular Forecast	Digital Zone Forecast
Value		79	74
Spatial Summarization	None	None	None
Temporal Summarization	Period	Hourly	Period
Type of Geography	Lat/Lon		
Horizontal Location	38.0° North Lat -78.0° West Lon		
Vertical Coordinate System	Surface		
Reference Time	2003-09-16T12:00		
Significance of Reference Time	Start of Forecast		
Start of Valid Time	2003-09-16T16:00:00Z	2003-09-16T16:00:00Z	2003-09-16T16:00:00Z
End of Valid Time	2003-09-17T04:00:00Z	2003-09-16T17:00:00Z	2003-09-17T04:00:00Z
Time Coordinate	UTC		
Period Name	This Afternoon ...	Not Applicable	This Afternoon ...

Table 1. DWML Content by Product

Appendix B: Requirements Correlation Matrix

Requirement	Spec	Spec	Spec	Spec
R2.1	S3.1.2	S4.1	S4.2	
R2.1.1	S4.1.1	S4.1.3		
R2.1.2	S4.1.6			
R2.1.3	S3.1.1			
R2.1.4	S4.1.2			
R2.1.4.1	S4.1.2.1			
R2.1.4.2	S4.1.2.2			
R2.1.4.3	S4.1.2.3			
R2.1.4.4	S4.1.2.4			
R2.1.5	S4.1.4			
R2.1.6	S4.1.6			
R2.1.7	S4.2.2			
R2.1.8	S4.2.2.1			
R2.1.9	S4.2.3			
R2.1.10	S4.2.4			
R2.1.11	S4.2.5			
R2.1.12	S4.2.6			
R2.1.13	S4.2.1			
R2.1.14	S4.1.6.1			
R2.2	S3.1.3 S5.3.4 S5.3.8 S5.3.11.2 S5.3.11.4.5	S5.3 S5.3.5 S5.3.9 S5.3.11.3 S5.3.8.2	S5.3.2 S5.3.6 S5.3.10 S5.3.11.4	S5.3.3 S5.3.7 S5.3.11 S5.3.11.5
R2.2.1	S5.3.2.4+ S5.3.6.4+ S5.3.9.4+ S5.3.11.4.3+ S5.3.3.7 S5.3.5.7 S5.3.7.7 S5.3.9.6	S5.3.3.4+ S5.3.7.4+ S5.3.10.2 S5.3.11.4.5.3+ S5.3.4.6 S5.3.6.6 S5.3.7.8 S5.3.9.7	S5.3.4.4+ S5.3.8.2.1+ S5.3.11.2.3+ S5.3.11.5.3+ S5.3.4.7 S5.3.6.7 S5.3.8.4 S5.4+	S5.3.5.4+ S5.3.8.2.1.6 S5.3.11.3.3+ S5.3.3.6 S5.3.5.6 S5.3.7.6 S5.3.8.5 S5.5+
R2.2.1.1	S5.3.2.1 S5.3.6.1 S5.3.11.3.1	S5.3.3.1 S5.3.7.1 S5.3.11.4.1	S5.3.4.1 S5.3.9.1 S5.3.11.4.5.1	S5.3.5.1 S5.3.11.2.1 S5.3.11.5.1
R2.2.1.2	S5.3.2.5 S5.3.6.5 S5.3.11.3.4	S5.3.3.5 S5.3.7.5 S5.3.11.4.4	S5.3.4.5 S5.3.9.5 S5.3.11.4.5.4	S5.3.5.5 S5.3.11.2.4 S5.3.11.5.4
R2.2.1.3	S5.3.2.2 S5.3.6.2	S5.3.3.2 S5.3.7.2	S5.3.4.2 S5.3.8.2.1.6.1	S5.3.5.2 S5.3.9.2

Requirement	Spec	Spec	Spec	Spec
	S5.3.11.2.2 S5.3.11.5.2	S5.3.11.3.2	S5.3.11.4.2	S5.3.11.4.5.2
R2.2.1.4	S5.3.2.4+ S5.3.6.4+ S5.3.11.3.3+	S5.3.3.4+ S5.3.7.4+ S5.3.11.4.3+	S5.3.4.4+ S5.3.9.4+ S5.3.11.4.5.3+	S5.3.5.4+ S5.3.11.2.3+ S5.3.11.5.3+
R2.2.1.5	S5.1.2.1 S5.1.6.2.3	S5.1.3.2 S5.1.6.3.5	S5.1.4.2	S5.1.5.2
R2.2.1.6	S5.2.2			
R2.2.2	S5.1	S5.1.1	S5.3.1	
R2.2.2.1	S5.1.2 S5.1.5.1	S5.1.3 S5.1.5.2	S5.1.4 S5.1.5.3	S5.1.5
R2.2.2.2	S5.1.2 S5.1.5.1 S5.1.5.2.1	S5.1.3+ S5.1.5.2 S5.1.5.2.2+	S5.1.4+ S5.1.5.3 S5.1.5.3.1 – S5.1.5.3.4	S5.1.5 S5.1.5.3
R2.2.2.3	S5.1.6.1	S5.1.7.1	S5.1.8.1	
R2.2.2.3.1	S5.1.6			
R2.2.2.3.1.1	S5.1.6.1			
R2.2.2.3.1.2	S5.1.6.2			
R2.2.2.3.2	S5.1.7			
R2.2.2.3.3	S5.1.8			
R2.2.3	S5.2 S5.3.4.3 S5.3.8.1	S5.2.3 – S5.2.5 S5.3.5.3 S5.3.9.3	S5.3.2.3 S5.3.6.3 S5.3.10.1	S5.3.3.3 S5.3.7.3 S5.3.11.1
R2.2.3.1	S5.2.4			
R2.2.3.2	S5.2.5			
R2.2.3.3	S5.2.1			
R2.2.3.4	S5.2.4.1			
R3.1	ALL			
R3.2	S7.2			
R3.3	S7.3			
R4.1	ALL			
R4.2	ALL			
R5.1	Appendix D			
R5.2	Appendix D			
R5.3	Appendix D			

Appendix C: Data Model

more follows = ... zero or one = ? zero or more = * one or more = + choose one = { }

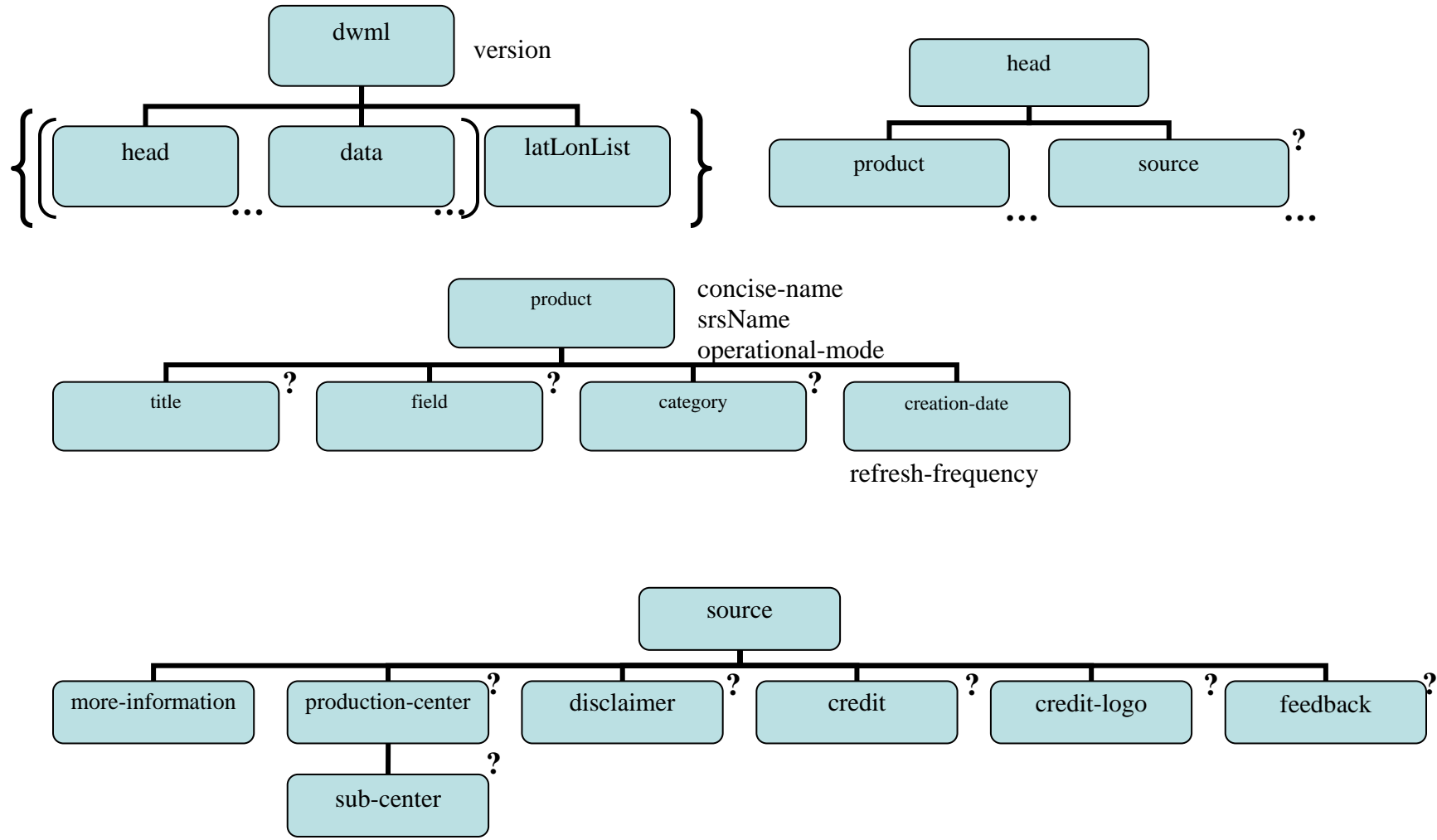

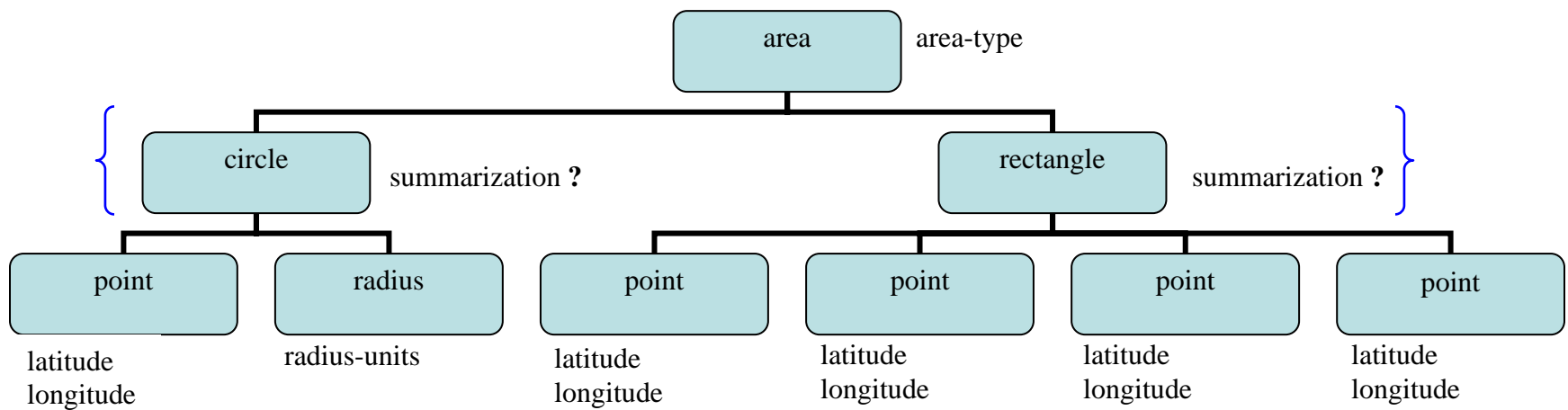
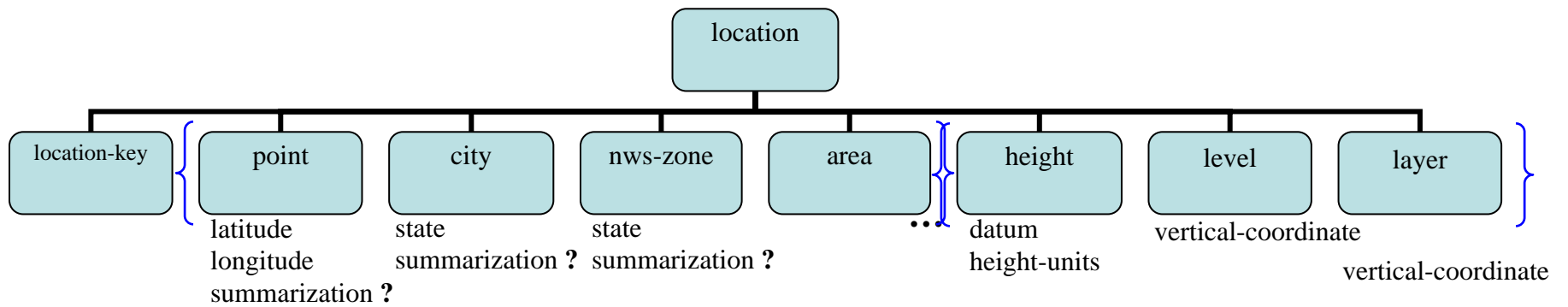
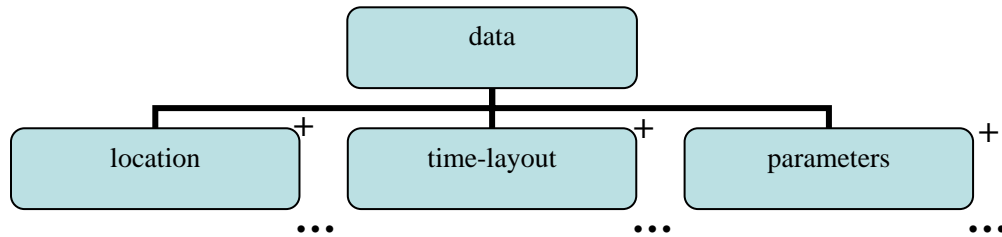

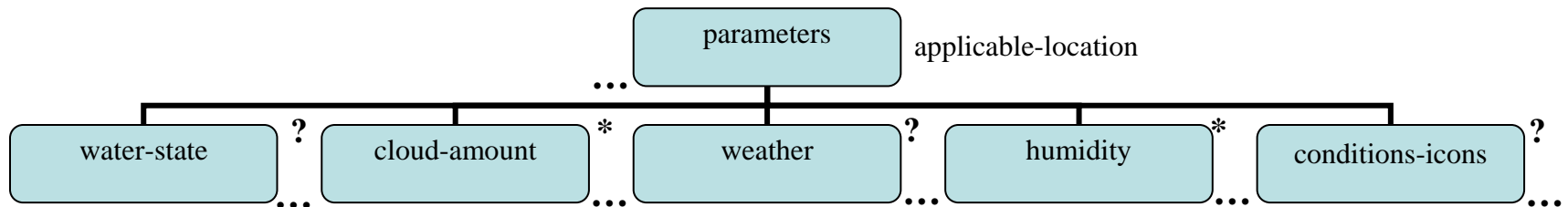
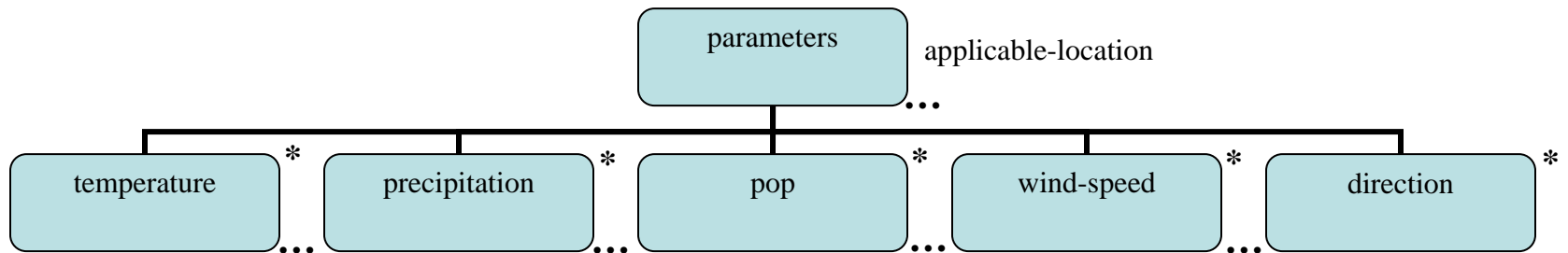
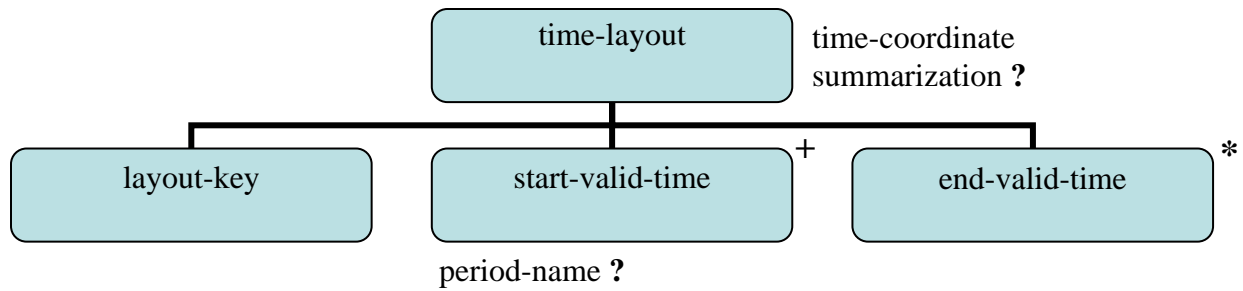

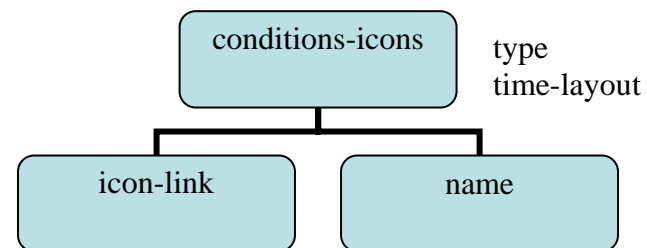
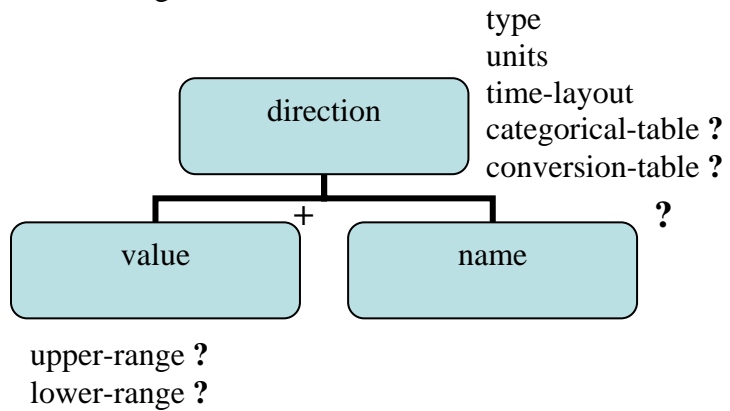
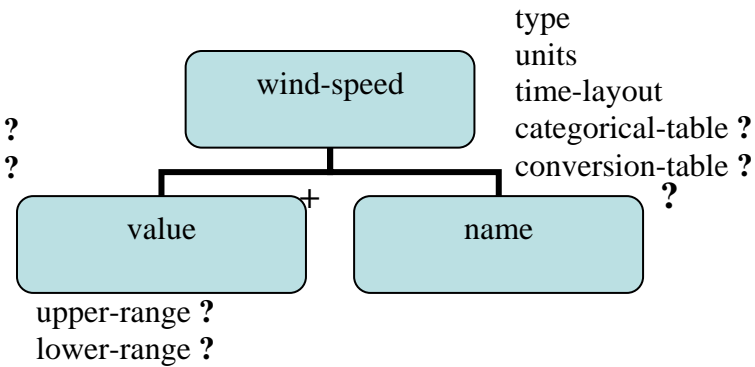
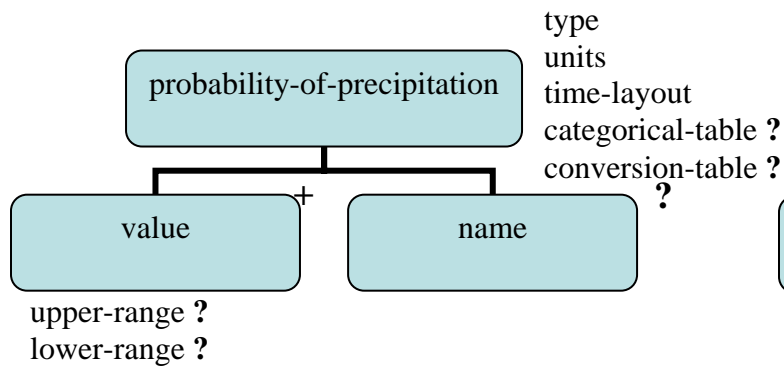
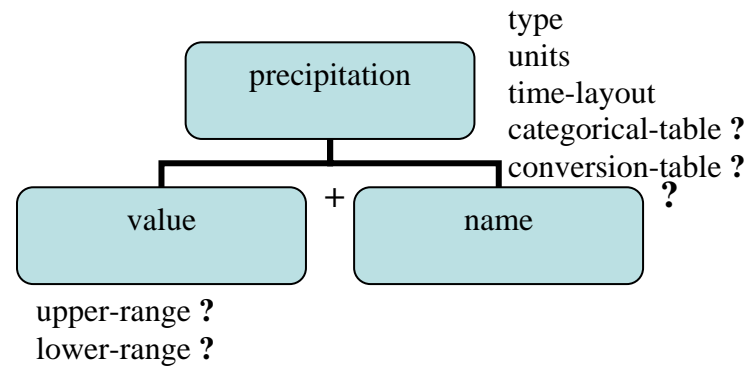
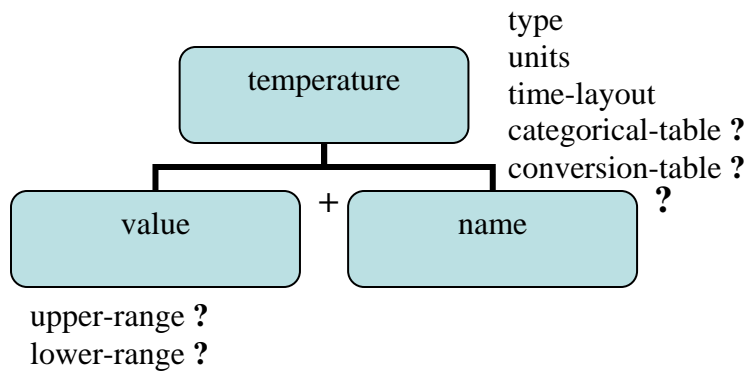

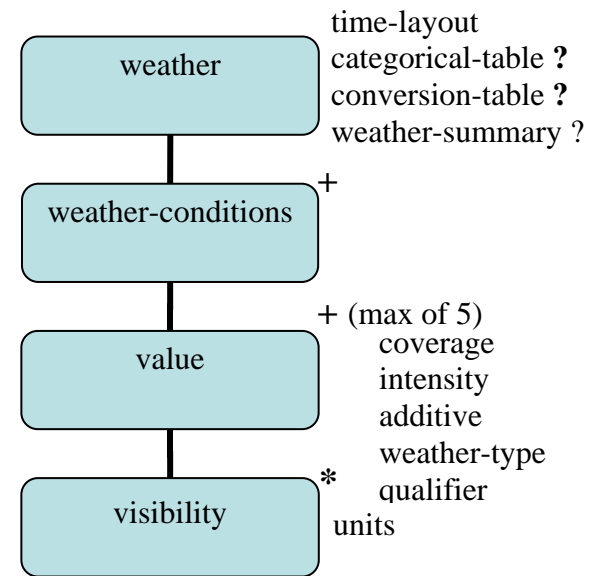
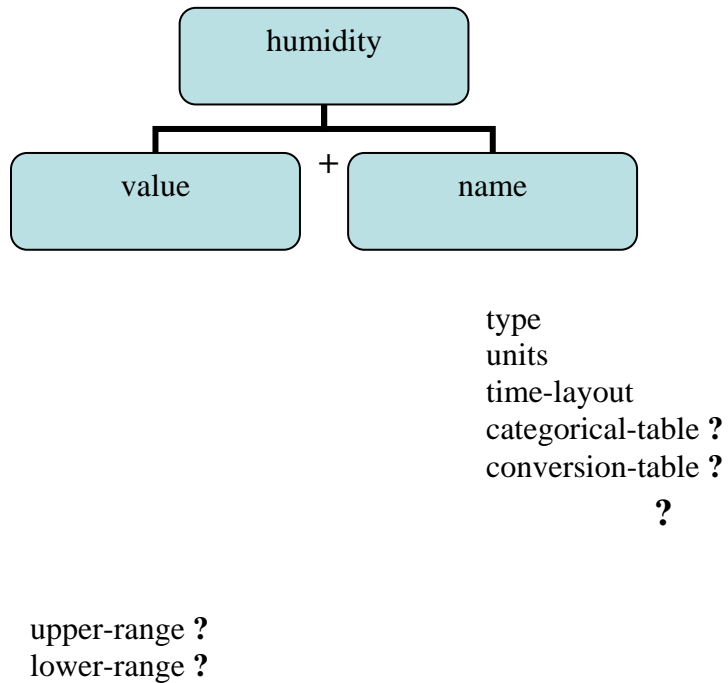
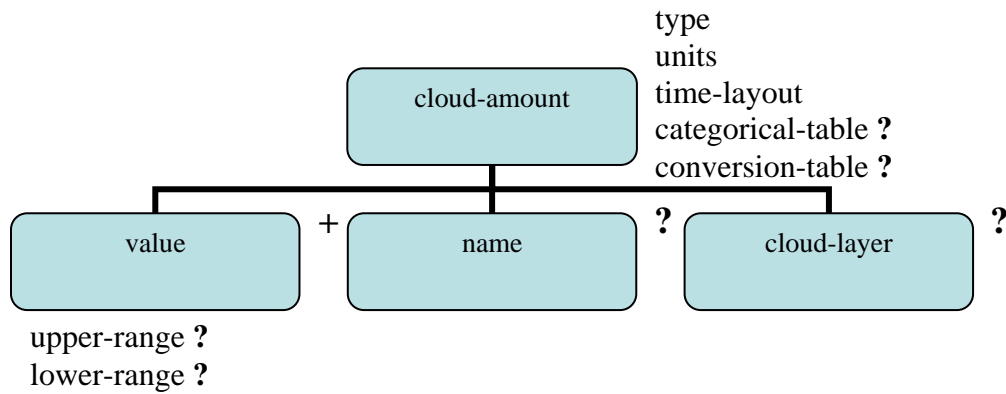

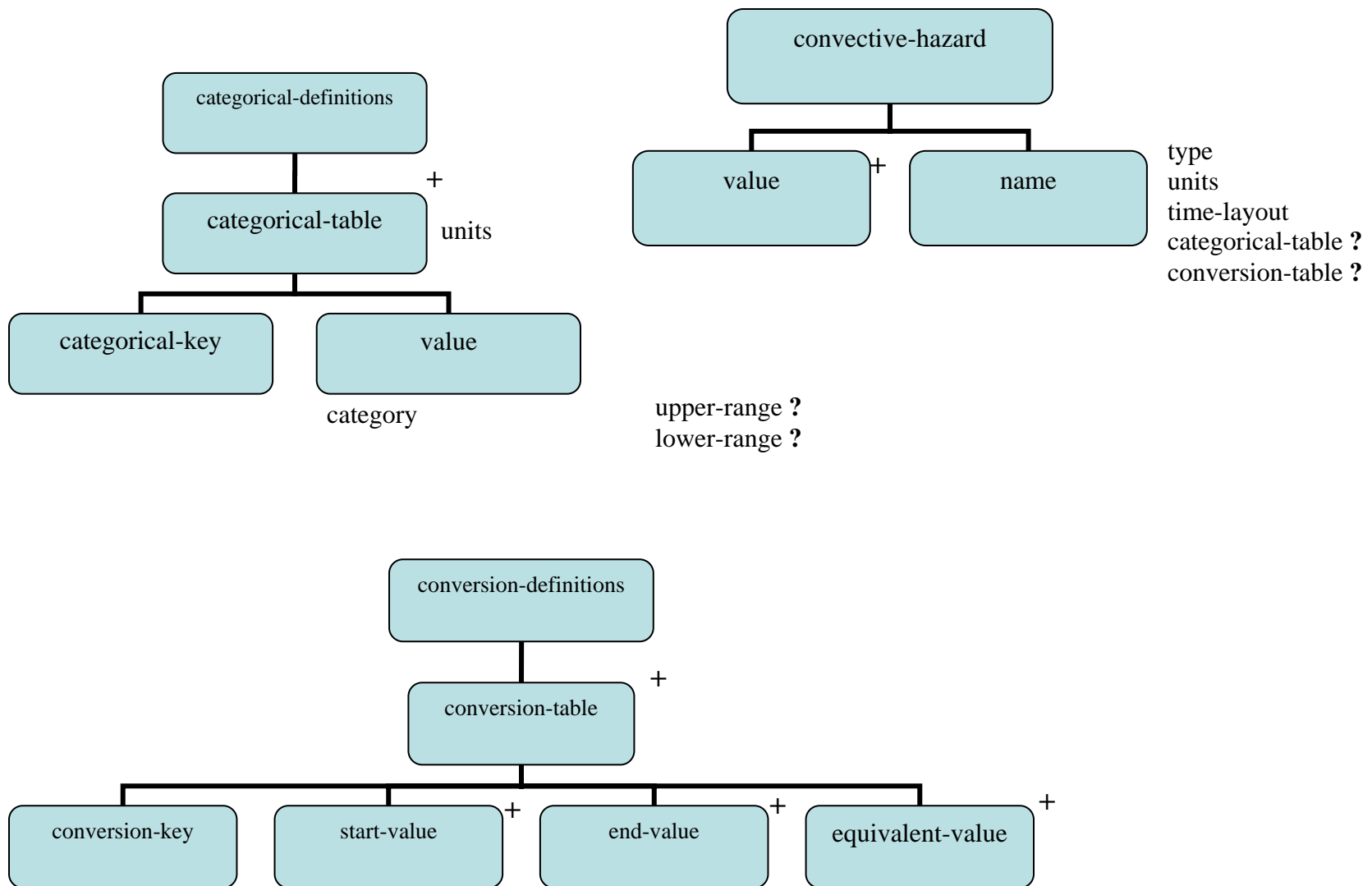

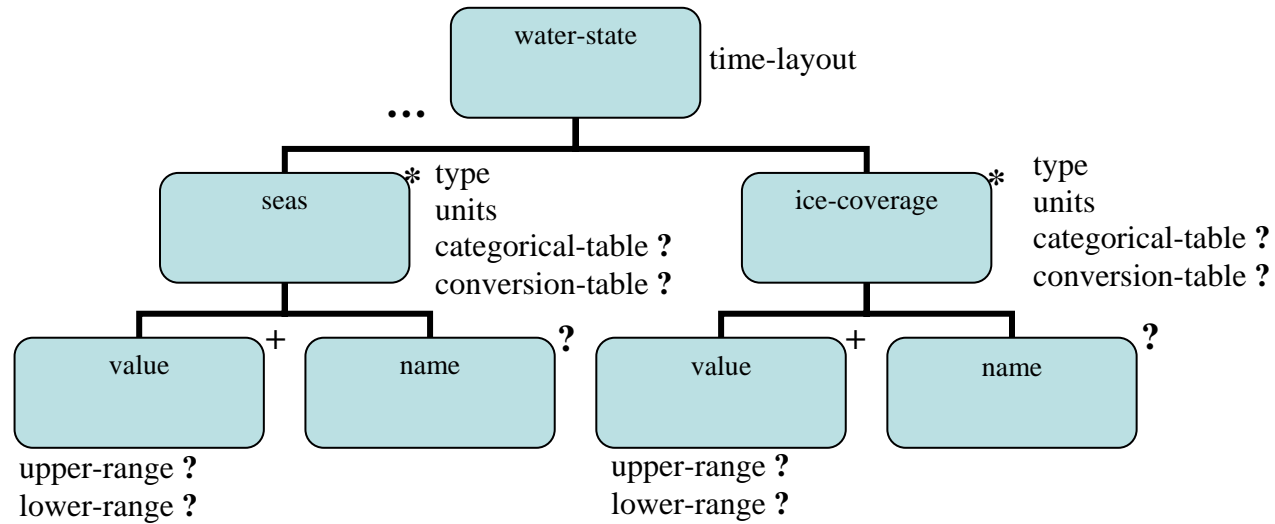
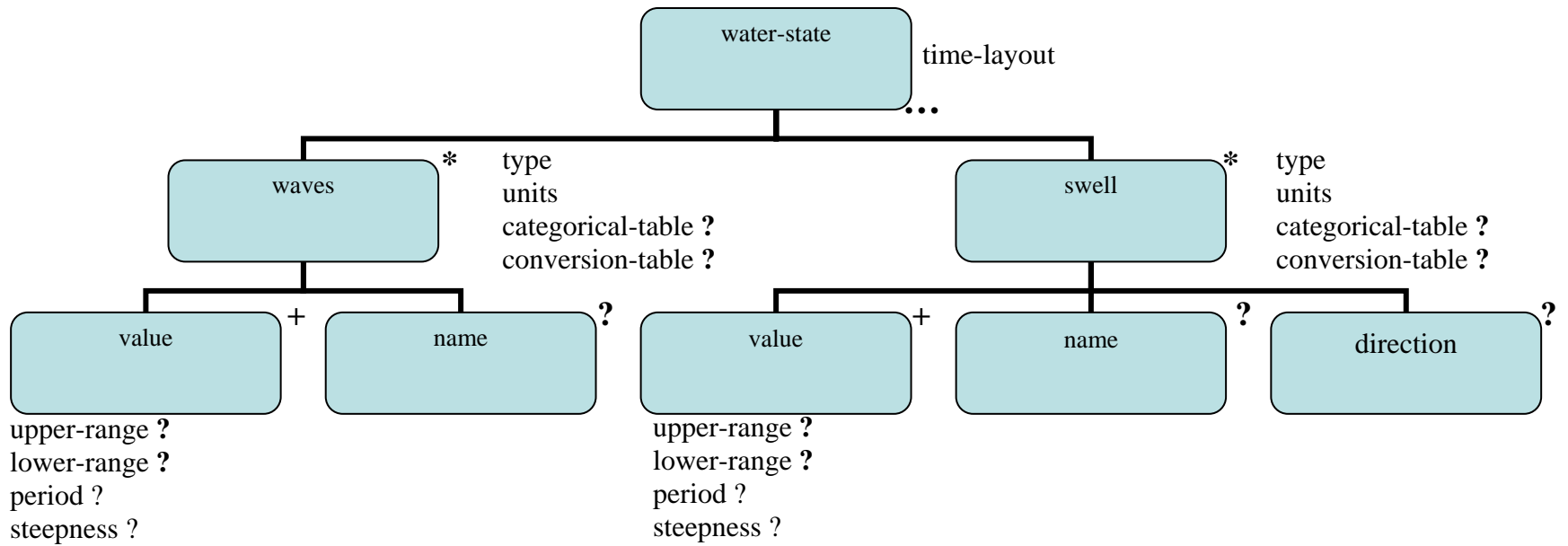

Appendix D: Product Samples

Forecast at a Glance

The grid point forecast ([on-line example](#)) contains the high or low temperature, the sky condition, and a weather icon. Figure 4 shows an example of the experimental forecast product.

NWS Web Site Product







This Afternoon	Tonight	Saturday	Saturday Night	Sunday	Sunday Night	Monday
						
Partly Cloudy	Partly Cloudy	Mostly Cloudy	Mostly Clear	Partly Cloudy	Partly Cloudy	Partly Cloudy
Hi 74 °F	Lo 58 °F	Hi 79 °F	Lo 55 °F	Hi 81 °F	Lo 59 °F	Hi 77 °F

Figure 4. Forecast at a Glance

Analogous DWML

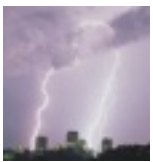
```

<dwml version="1.0">
<head>
  <product srsName="WGS 1984" concise-name="glance" operational-mode="official">
    <title>NWS Forecast at a Glance</product-title>
    <field>meteorological</field>
    <category>forecast</category></
    <creation-date refresh-frequency="P1H"> 2003-10-22T15:30:03Z</creation-date>
  </product>
  <source>
    <more-information>http://www.crh.noaa.gov/ifps/MapClick.php</more-information>
    <production-center>Meteorological Development Laboratory, <sub-center>Statistical Modeling
    Branch</sub-center></production-center>
  </production-center>
    <disclaimer>http://www.nws.noaa.gov/disclaimer.html</disclaimer>
    <credit>http://www.nws.noaa.gov/</credit>
    <credit-logo>http://www.nws.noaa.gov/images/noaaleft.jpg</credit-logo>
    <feedback>http://www.nws.noaa.gov/mdl/</feedback>
  </source>
</head>
<data>
  <location>
    <location-key>point1</location-key>
    <point latitude="38.0" longitude="-78.0"/>

```

```

</location>
<time-layout time-coordinate="local time" summarization="none">
  <layout-key>k-p12h-n4-1</layout-key>
  <start-valid-time period-name="This Afternoon">2003-10-15T12:00:00-05:00</start-valid-time>
  <end-valid-time>2003-10-15T23:59:59-05:00</end-valid-time>
  <start-valid-time period-name="Saturday">2003-10-16T12:00:00-05:00</start-valid-time>
  <end-valid-time>2003-10-16T23:59:59-05:00</end-valid-time>
  <start-valid-time period-name="Sunday">2003-10-17T12:00:00-05:00</start-valid-time>
  <end-valid-time>2003-10-17T23:59:59-05:00</end-valid-time>
  <start-valid-time period-name="Monday">2003-10-18T12:00:00-05:00</start-valid-time>
  <end-valid-time>2003-10-18T23:59:59-05:00</end-valid-time>
</time-layout>
<time-layout time-coordinate="local time" summarization="none">
  <layout-key>k-p13h-n3-2</layout-key>
  <start-valid-time period-name="Tonight">2003-10-16T00:00:00-05:00</start-valid-time>
  <end-valid-time>2003-10-16T12:59:59-05:00</end-valid-time>
  <start-valid-time period-name="Saturday Night">2003-10-17T00:00:00-05:00</start-valid-time>
  <end-valid-time>2003-10-17T12:59:59-05:00</end-valid-time>
  <start-valid-time period-name="Sunday Night">2003-10-18T00:00:00-05:00</start-valid-time>
  <end-valid-time>2003-10-18T12:59:59-05:00</end-valid-time>
</time-layout>
<time-layout time-coordinate="local time" summarization="mean">
  <layout-key>k-p12h-n7-3</layout-key>
  <start-valid-time period-name="This Afternoon">2003-10-15T16:00:00-04:00</start-valid-time>
  <end-valid-time>2003-10-15T21:59:59-04:00</end-valid-time>
  <start-valid-time period-name="Tonight">2003-10-15T22:00:00-04:00</start-valid-time>
  <end-valid-time>2003-10-16T09:59:59-04:00</end-valid-time>
  <start-valid-time period-name="Saturday">2003-10-16T10:00:00-04:00</start-valid-time>
  <end-valid-time>2003-10-16T21:59:59-04:00</end-valid-time>
  <start-valid-time period-name="Saturday-Night">2003-10-16T22:00:00-04:00</start-valid-time>
  <end-valid-time>2003-10-17T09:59:59-04:00</end-valid-time>
  <start-valid-time period-name="Sunday">2003-10-17T10:00:00-04:00</start-valid-time>
  <end-valid-time>2003-10-17T21:59:59-04:00</end-valid-time>
  <start-valid-time period-name="Sunday-Night">2003-10-17T22:00:00-04:00</start-valid-time>
  <end-valid-time>2003-10-18T09:59:59-04:00</end-valid-time>
  <start-valid-time period-name="Monday">2003-10-18T10:00:01-04:00</start-valid-time>
  <end-valid-time>2003-10-19T21:59:59-04:00</end-valid-time>
</time-layout>
<parameters applicable-location='point1'>
  <conversion-definitions>
    <conversion-table units="percent">
      <conversion-key>sky-cover</conversion-key>
      <start-value>0</start-value>
      <end-value>6</end-value>
      <equivalent-value>clear</equivalent-value>
      <start-value>7</start-value>
      <end-value>31</end-value>
      <equivalent-value>mostly clear</equivalent-value>
      <start-value>32</start-value>
      <end-value>69</end-value>
      <equivalent-value>partly cloudy</equivalent-value>
      <start-value>70</start-value>
      <end-value>94</end-value>
      <equivalent-value>mostly cloudy</equivalent-value>
      <start-value>95</start-value>
      <end-value>100</end-value>
    </conversion-table>
  </conversion-definitions>
</parameters>

```

```

        <equivalent-value>cloudy</equivalent-value>
    </conversion-table>
</conversion-definitions>
<temperature type="maximum" units="F" time-layout="k-p12h-n4-1">
    <name>Maximum Temperature</name>
    <value>74</value>
    <value>79</value>
    <value>81</value>
    <value>77</value>
</temperature>
<temperature type="minimum" units="F" time-layout="k-p12h-n3-2">
    <name>Minimum Temperature</name>
    <value>58</value>
    <value>59</value>
    <value>55</value>
</temperature>
<cloud-amount type="total" units="percent" time-layout="k-p12h-n7-3" conversion-table="sky-cover">
    <amount-name>Total Sky Cover</amount-name>
    <amount-name>45</amount-name>
    <amount-name>75</amount-name>
    <amount-name>55</amount-name>
    <amount-name>60</amount-name>
    <amount-name>50</amount-name>
    <amount-name>77</amount-name>
    <amount-name>53</amount-name>
</cloud-amount>
<conditions-icons time-layout="k-p12h-n7-3">
    <icon-link>http://www.nws.noaa.gov/weather/images/fcicons/nsct.jpg</icon-link>
    <icon-link>http://www.nws.noaa.gov/weather/images/fcicons/nbkn.jpg</icon-link>
    <icon-link>http://www.nws.noaa.gov/weather/images/fcicons/tsra20.jpg</icon-link>
    <icon-link>http://www.nws.noaa.gov/weather/images/fcicons/tsra40.jpg</icon-link>
    <icon-link>http://www.nws.noaa.gov/weather/images/fcicons/tsra40.jpg</icon-link>
    <icon-link>http://www.nws.noaa.gov/weather/images/fcicons/tsra40.jpg</icon-link>
    <icon-link>http://www.nws.noaa.gov/weather/images/fcicons/tsra40.jpg</icon-link>
    <icon-link>http://www.nws.noaa.gov/weather/images/fcicons/ntsra20.jpg</icon-link>
    <icon-link>http://www.nws.noaa.gov/weather/images/fcicons/hi_nshwrs20.jpg</icon-link>
</conditions-icons>
</parameters>
</data>
</dwml>

```

Digital Tabular Forecast

The forecast ([on-line example](#)) contains hourly values for temperature, dew point temperature, probability of precipitation, wind direction and speed, sky cover, as well as precipitation type information. Figure 5 shows an example of this experimental forecast product.

Sample Digital Tabular Forecast Product

	09/16													09/17						
	16	17	18	19	20	21	22	23	00	01	02	03	04	05	06	07				
Temp	79	79	78	75	72	70	67	65	62	59	58	58	57	57	56	56				
Dewp	52	51	50	50	49	48	48	47	46	46	46	46	46	47	48	48				
PoP	0	0	0	0	0	0	0	0	0	0	0	0	0	0	0	0				
Sky(%)	13	10	6	3	2	2	2	2	3	5	7	9	10	12	14	16				
WDir	NW	NW	NW	NW	NW	NW	NW	NW	NW	NW	NW	NW	NW	NW	NW	NW				
WSpd	8	8	8	6	3	2	2	2	3	5	5	6	6	6	6	6				
GSpd								5												
Rain	--	--	--	--	--	--	--	--	--	--	--	--	--	--	--	--				
Tstm	--	--	--	--	--	--	--	--	--	--	--	--	--	--	--	--				

Figure 5. Digital/Tabular Forecast

Analogous DWML

```
<dwml version="1.0">
<head>
  <product srsName="WGS 1984" concise-name=" digital-tabular" operational-mode="official">
    <title>NWS Forecast at a Glance</product-title>
    <field>meteorological</field>
    <category>forecast</category>
    <creation-date refresh-frequency="PIH"> 2003-10-22T15:30:03Z</creation-date>
  </product>
  <source>
    <more-information>http://www.crh.noaa.gov/ifps/MapClick.php</more-information>
    <production-center>Meteorological Development Laboratory, <sub-center>Statistical Modeling
    Branch</sub-center></production-center>
    </production-center>
    <disclaimer>http://www.nws.noaa.gov/disclaimer.html</disclaimer>
    <credit>http://www.nws.noaa.gov/</credit>
    <credit-logo>http://www.nws.noaa.gov/images/noaaleft.jpg</credit-logo>
    <feedback>http://www.nws.noaa.gov/mdl/</feedback>
  </source>
</head>
<data>
  <location>
    <location-key>point1</location-key>
```

```

    <point latitude="38.0" longitude="-78.0"/>
  </location>
  <time-layout time-coordinate="UTC" summarization="none">
    <layout-key>k-p1h-n16-1</layout-key>
    <start-valid-time>2003-09-16T20:00:00Z</start-valid-time>
    <start-valid-time>2003-09-16T21:00:00Z</start-valid-time>
    <start-valid-time>2003-09-16T22:00:00Z</start-valid-time>
    <start-valid-time>2003-09-16T23:00:00Z</start-valid-time>
    <start-valid-time>2003-09-16T00:00:00Z</start-valid-time>
    <start-valid-time>2003-09-16T01:00:00Z</start-valid-time>
    <start-valid-time>2003-09-16T02:00:00Z</start-valid-time>
    <start-valid-time>2003-09-16T03:00:00Z</start-valid-time>
    <start-valid-time>2003-09-16T04:00:00Z</start-valid-time>
    <start-valid-time>2003-09-16T05:00:00Z</start-valid-time>
    <start-valid-time>2003-09-16T06:00:00Z</start-valid-time>
    <start-valid-time>2003-09-16T07:00:00Z</start-valid-time>
    <start-valid-time>2003-09-16T08:00:00Z</start-valid-time>
    <start-valid-time>2003-09-16T09:00:00Z</start-valid-time>
    <start-valid-time>2003-09-16T10:00:00Z</start-valid-time>
    <start-valid-time>2003-09-16T11:00:00Z</start-valid-time>
  </time-layout>
  <parameters applicable-location='point1'>
    <conversion-definitions>
      <conversion-table>
        <conversion-key>wind-direction</conversion-key>
        <start-value>23</start-value>
        <end-value>67</end-value>
        <equivalent-value>NE</equivalent-value>
        <start-value>68</start-value>
        <end-value>112</end-value>
        <equivalent-value>E</equivalent-value>
        <start-value>113</start-value>
        <end-value>157</end-value>
        <equivalent-value>SE</equivalent-value>
        <start-value>158</start-value>
        <end-value>202</end-value>
        <equivalent-value>SE</equivalent-value>
        <start-value>203</start-value>
        <end-value>247</end-value>
        <equivalent-value>SW</equivalent-value>
        <start-value>248</start-value>
        <end-value>292</end-value>
        <equivalent-value>W</equivalent-value>
        <start-value>293</start-value>
        <end-value>337</end-value>
        <equivalent-value>NW</equivalent-value>
        <start-value>338</start-value>
        <end-value>22</end-value>
        <equivalent-value>N</equivalent-value>
      </conversion-table>
    </conversion-definitions>
    <temperature type="temperature" units="F" time-layout="k-p1h-n16-1">
      <name>Hourly Temperatures</name>
      <value>79</value>
      <value>79</value>
      <value>78</value>
    </temperature>
  </parameters>

```



```

    <value>75</value>
    <value>72</value>
    <value>70</value>
    <value>67</value>
    <value>65</value>
    <value>62</value>
    <value>59</value>
    <value>58</value>
    <value>58</value>
    <value>57</value>
    <value>57</value>
    <value>56</value>
    <value>56</value>
  </temperature>
  <temperature type="dew point" units="F" time-layout="k-p1h-n16-1">
    <name>Hourly Dewpoint Temperatures</name>
    <value>52</value>
    <value>51</value>
    <value>50</value>
    <value>50</value>
    <value>49</value>
    <value>48</value>
    <value>48</value>
    <value>47</value>
    <value>46</value>
    <value>46</value>
    <value>46</value>
    <value>46</value>
    <value>46</value>
    <value>46</value>
    <value>47</value>
    <value>48</value>
    <value>48</value>
  </temperature>
  <probability-of-precipitation type="12 hour" units="percent" time-layout="k-p1h-n16-1">
    <name>12 Hour Probability of Precipitation</name>
    <value>0</value>
    <value>0</value>
    <value>0</value>
    <value>0</value>
    <value>0</value>
    <value>0</value>
    <value>0</value>
    <value>0</value>
    <value>0</value>
    <value>0</value>
    <value>0</value>
    <value>0</value>
    <value>0</value>
    <value>0</value>
    <value>0</value>
    <value>0</value>
    <value>0</value>
    <value>0</value>
    <value>0</value>
    <value>0</value>
  </probability-of-precipitation>
  <cloud-amount type="total" units="percent" time-layout="k-p1h-n16-1">
    <amount-name>Total Sky Cover</amount -name>
    <value>13</value>
    <value>10</value>

```

```

        <value>6</value>
        <value>3</value>
        <value>2</value>
        <value>2</value>
        <value>2</value>
        <value>2</value>
        <value>3</value>
        <value>5</value>
        <value>7</value>
        <value>9</value>
        <value>10</value>
        <value>12</value>
        <value>14</value>
        <value>16</value>
    </cloud-amount>
    <direction type="wind" units="degrees true" time-layout="k-p1h-n16-1" conversion-table="wind-direction">
        <name>Wind Direction</name>
        <value>315</value>
        <value>315</value>
        <value>315</value>
        <value>315</value>
        <value>315</value>
        <value>315</value>
        <value>315</value>
        <value>315</value>
        <value>315</value>
        <value>315</value>
        <value>315</value>
        <value>315</value>
        <value>315</value>
        <value>315</value>
        <value>315</value>
        <value>315</value>
        <value>315</value>
    </direction>
    <wind-speed type="sustained" units="knots" time-layout="k-p1h-n16-1">
        <name>Sustained Wind Speed</name>
        <value>8</value>
        <value>8</value>
        <value>8</value>
        <value>6</value>
        <value>3</value>
        <value>2</value>
        <value>2</value>
        <value>2</value>
        <value>3</value>
        <value>5</value>
        <value>5</value>
        <value>6</value>
        <value>6</value>
        <value>6</value>
        <value>6</value>
        <value>6</value>
    </wind-speed>
    <wind-speed type="gust" units="knots" time-layout="k-p1h-n16-1">
        <name>Wind SpeedGusts</name>
        <value xsi:nil="true"/>
    </wind-speed>

```

```
<value xsi:nil="true"/>
<value xsi:nil="true"/>
<value xsi:nil="true"/>
<value xsi:nil="true"/>
<value xsi:nil="true"/>
<value xsi:nil="true"/>
<value>5</value>
<value xsi:nil="true"/>
<value xsi:nil="true"/>
<value xsi:nil="true"/>
<value xsi:nil="true"/>
<value xsi:nil="true"/>
<value xsi:nil="true"/>
<value xsi:nil="true"/>
<value xsi:nil="true"/>
</wind-speed>
<weather time-layout="k-plh-n16-1">
  <weather-conditions xsi:nil="true"/>
  <weather-conditions xsi:nil="true"/>
  <weather-conditions xsi:nil="true"/>
  <weather-conditions xsi:nil="true"/>
  <weather-conditions xsi:nil="true"/>
  <weather-conditions xsi:nil="true"/>
  <weather-conditions xsi:nil="true"/>
  <weather-conditions xsi:nil="true"/>
  <weather-conditions xsi:nil="true"/>
  <weather-conditions xsi:nil="true"/>
  <weather-conditions xsi:nil="true"/>
  <weather-conditions xsi:nil="true"/>
  <weather-conditions xsi:nil="true"/>
  <weather-conditions xsi:nil="true"/>
  <weather-conditions xsi:nil="true"/>
  <weather-conditions xsi:nil="true"/>
  <weather-conditions xsi:nil="true"/>
</weather>
</parameters>
</data>
</dwml>
```

Digital Zone Forecast

This product is similar to the Forecast at a Glance in that it uses 12 hour forecast periods to summarize the NDFD data. The digital zone forecast is like the Digital Tabular Forecast in terms of its use of an extensive number of weather elements. Figure 6 shows an example product.

Sample Digital Zone Forecast Product

	This Afternoon	Tonight	Saturday	Saturday Night	Sunday	Sunday Night
Sky Cover	30 percent	25 percent	20 percent	35 percent	60 percent	65 percent
High/Low	74 °F	58 °F	79 °F	55 °F	81 °F	59 °F
Wind Direction	NW	NW	SW	SW	SW	SE
Wind Speed	5 -10	5 -10	5 -10	5 -10	10 - 15	5 -10
Probability- of- precipitation	0	0	0	0	40	60
Weather Type	None	None	None	None	Thunderstorms	Showers

Figure 6. Digital Zone Forecast

Analogous DWML

```
<dwml version="1.0">
<head>
  <product srsName="WGS 1984" concise-name="digital-zone" operational-mode="official">
    <creation-date refresh-frequency="P1H"> 2003-10-22T15:30:03Z</creation-date>
  </product>
  <source>
    <more-information>http://www.crh.noaa.gov/ifps/MapClick.php</more-information>
  </source>
</head>
<data>
  <location>
    <location-key>point1</location-key>
    <point latitude="38.0" longitude="-78.0"/>
  </location>
  <time-layout time-coordinate="UTC" summarization="none">
    <layout-key>k-p12h-n3-1</layout-key>
    <start-valid-time period-name="This Afternoon">2003-10-15T12:00:00Z</start-valid-time>
  </time-layout>
</data>
</dwml>
```

```

<end-valid-time>2003-10-16T23:59:59Z</end-valid-time>
<start-valid-time period-name="Saturday">2003-10-16T12:00:00Z</start-valid-time>
<end-valid-time>2003-10-17T23:59:59Z</end-valid-time>
<start-valid-time period-name="Sunday">2003-10-17T12:00:00Z</start-valid-time>
<end-valid-time>2003-10-18T23:59:59Z</end-valid-time>
</time-layout>
<time-layout time-coordinate="local-time" summarization="none">
  <layout-key>k-p12h-n3-2</layout-key>
  <start-valid-time period-name="Tonight">2003-10-16T00:00:00Z</start-valid-time>
  <end-valid-time>2003-10-16T11:59:59Z</end-valid-time>
  <start-valid-time period-name="Saturday Night"> 2003-10-17T00:00:00Z</start-valid-time>
  <end-valid-time>2003-10-17T11:59:59Z </end-valid-time>
  <start-valid-time period-name="Sunday Night"> 2003-10-18T00:00:00Z</start-valid-time>
  <end-valid-time>2003-10-18T11:59:59Z </end-valid-time>
</time-layout>
<parameters applicable-location='point1'>
  <conversion-definitions>
    <conversion-table>
      <conversion-key>wind-direction</conversion-key>
      <start-value>23</start-value>
      <end-value>67</end-value>
      <equivalent-value>NE</equivalent-value>
      <start-value>68</start-value>
      <end-value>112</end-value>
      <equivalent-value>E</equivalent-value>
      <start-value>113</start-value>
      <end-value>157</end-value>
      <equivalent-value>SE</equivalent-value>
      <start-value>158</start-value>
      <end-value>202</end-value>
      <equivalent-value>SE</equivalent-value>
      <start-value>203</start-value>
      <end-value>247</end-value>
      <equivalent-value>SW</equivalent-value>
      <start-value>248</start-value>
      <end-value>292</end-value>
      <equivalent-value>W</equivalent-value>
      <start-value>293</start-value>
      <end-value>337</end-value>
      <equivalent-value>NW</equivalent-value>
      <start-value>338</start-value>
      <end-value>22</end-value>
      <equivalent-value>N</equivalent-value>
    </conversion-table>
  </conversion-definitions>
  <temperature type="maximum" units="F" time-layout="k-p12h-n3-1">
    <value>74</value>
    <value>79</value>
    <value>81</value>
  </temperature>
  <temperature type="minimum" units="F" time-layout="k-p12h-n3-2">
    <value>58</value>
    <value>55</value>
    <value>59</value>
  </temperature>
  <cloud-amount type="total" units="percent" time-layout="k-p12h-n3-1">

```

```

    <name>Total Sky Cover</ name>
    <value>30</value>
    <value>20</value>
    <value>60</value>
</cloud-amount>
<cloud-amount type="total" units="percent" time-layout="k-p12h-n3-2">
    <name>Total Sky Cover</ name>
    <value>25</value>
    <value>35</value>
    <value>65</value>
</cloud-amount>
<direction type="wind" units="degrees true" time-layout="k-p12h-n3-1" conversion-table="wind-direction">
    <value>315</value>
    <value>225</value>
    <value>225</value>
</direction>
<direction type="wind" units="degrees true" time-layout="k-p12h-n3-2" conversion-table="wind-direction">
    <value>315</value>
    <value>135</value>
    <value>225</value>
</direction>
<wind-speed type="sustained" units="knots" time-layout="k-p12h-n3-1">
    <value lower-range="5" upper-range="10">6</value>
    <value lower-range="5" upper-range="10">8</value>
    <value lower-range="10" upper-range="15">12</value>
</wind-speed>
<wind-speed type="sustained" units="knots" time-layout="k-p12h-n3-2">
    <value lower-range="5" upper-range="10">6</value>
    <value lower-range="5" upper-range="10">8</value>
    <value lower-range="5" upper-range="10">7</value>
</wind-speed>
<probability-of-precipitation type="12-hour" units="percent" time-layout="k-p12h-n3-1">
    <value>0</value>
    <value>0</value>
    <value>40</value>
</probability-of-precipitation>
<probability-of-precipitation type="12-hour" units="percent" time-layout="k-p12h-n3-2">
    <value>0</value>
    <value>0</value>
    <value>60</value>
</probability-of-precipitation>
<weather time-layout=" k-p12h-n3-1">
    <weather-conditions xsi:nil="true" />
    <weather-conditions xsi:nil="true" />
    <weather-conditions>
        <value coverage="scattered" intensity="moderate" weather-type="thunderstorms" qualifier="none" />
    </weather-conditions>
</weather>
<weather time-layout=" k-p12h-n3-2">
    <weather-conditions xsi:nil="true" />
    <weather-conditions xsi:nil="true" />
    <weather-conditions>
        <value coverage="chance" intensity="light" weather-type="showers" qualifier="none" />
    </weather-conditions>
</weather>
</parameters>

```

<data>
<dwml>

Model Output Statistics Bulletin

This is not an NDFD product. Rather, it is an operational text bulletin produced by the Meteorological Development Laboratory. Figure 7 shows a sample bulletin.

Sample Model Output Statistics Product

KAKQ	AVN	MOS	GUIDANCE	10/24/2003 1200 UTC																											
DT /OCT	24/OCT	25													/OCT	26					/OCT	27									
HR	18	21	00	03	06	09	12	15	18	21	00	03	06	09	12	15	18	21	00	06	12										
N/X							38							62							57			70	59						
TMP	57	57	44	41	40	40	41	55	60	60	56	58	60	60	60	65	68	67	63	64	64										
DPT	27	29	36	35	35	36	39	46	49	52	54	57	59	59	59	61	61	61	60	59	60										
CLD	CL	CL	CL	CL	CL	CL	CL	BK	BK	BK	BK	BK	BK	OV	OV	OV	OV	OV	OV	OV	OV										
WDR	36	00	00	00	00	00	00	19	21	00	00	20	21	21	21	21	22	22	22	18	23										
WSP	02	00	00	00	00	00	00	05	05	00	00	02	02	03	03	06	05	02	03	04	06										
P06				0				0				3				2				11			20			32			35	20	57
P12							0							10							22			59	60						
Q06				0				0				0				0				0			0	0	2						
Q12							0							0							0			1	2						
T06			0/24			0/19			0/0			0/27			0/19			2/19			3/0			2/30			6/25	18/	1		
T12				0/29				0/27				2/32				5/30				18/40											
POZ	0	0	0	0	0	0	0	0	0	0	0	0	0	0	0	0	0	0	0	0	0										
POS	0	0	0	0	0	0	0	0	0	0	0	0	0	0	0	0	0	0	0	0	0										
TYP	R	R	R	R	R	R	R	R	R	R	R	R	R	R	R	R	R	R	R	R	R										
CIG	7	7	7	7	7	7	7	7	5	5	5	7	5	5	4	4	4	5	5	4	3										
VIS	7	7	7	7	7	7	7	7	7	7	7	7	6	3	2	6	7	7	7	1	4										
OBV	N	N	N	N	N	N	N	N	N	N	N	N	BR	FG	BR	HZ	N	N	N	FG	BR										

Figure 7: Sample Model Output Statistics Bulletin.

Analogous DWML

```

<dwml version="1.0">
<head>
  <product srsName="WGS 1984" concise-name=" digital-tabular" operational-mode="experimental">
    <title>NWS Forecast at a Glance</product-title>
    <field>meteorological</field>
    <category>forecast</category>
    <creation-date refresh-frequency="PIH"> 2003-10-24T10:30:03Z</creation-date>
  </product>
  <source>
    <more-information>http://www.nws.noaa.gov/mdl/synop/products.shtml</more-information>
    <production-center>Meteorological Development Laboratory, <sub-center>Statistical Modeling
    Branch</sub-center></production-center>
    <disclaimer>http://www.nws.noaa.gov/disclaimer.html</disclaimer>
    <credit>http://www.nws.noaa.gov/</credit>
    <credit-logo>http://www.nws.noaa.gov/images/noaaleft.jpg</credit-logo>
    <feedback>http://www.nws.noaa.gov/mdl/</feedback>
  </source>
</head>
<data>
  <location>

```



```

    <location-key>point1</location-key>
    <point latitude="36.9872" longitude="-77.0011"/>
</location>
<time-layout time-coordinate="local-time" summarization="none">
  <layout-key>k-p12h-n2-1</layout-key>
  <start-valid-time>2003-10-25T12:00:00-05:00</start-valid-time>
  <end-valid-time>2003-10-25T23:59:59-05:00</end-valid-time>
  <start-valid-time>2003-10-26T12:00:00-05:00</start-valid-time>
  <end-valid-time>2003-10-26T23:59:59-05:00</end-valid-time>
</time-layout>
<time-layout time-coordinate="local time" summarization="none">
  <layout-key>k-p13h-n3-2</layout-key>
  <start-valid-time>2003-10-25T00:00:00-05:00</start-valid-time>
  <end-valid-time>2003-10-25T12:59:59-05:00</end-valid-time>
  <start-valid-time>2003-10-26T00:00:00-05:00</start-valid-time>
  <end-valid-time>2003-10-26T12:59:59-05:00</end-valid-time>
  <start-valid-time>2003-10-27T00:00:00-05:00</start-valid-time>
  <end-valid-time>2003-10-27T12:59:59-05:00</end-valid-time>
</time-layout>
<time-layout time-coordinate="UTC" summarization="none">
  <layout-key>k-p3h-n21-3</layout-key>
  <start-valid-time>2003-10-24T18:00:00Z</start-valid-time>
  <start-valid-time>2003-10-24T21:00:00Z</start-valid-time>
  <start-valid-time>2003-10-25T00:00:00Z</start-valid-time>
  <start-valid-time>2003-10-25T03:00:00Z</start-valid-time>
  <start-valid-time>2003-10-25T06:00:00Z</start-valid-time>
  <start-valid-time>2003-10-25T09:00:00Z</start-valid-time>
  <start-valid-time>2003-10-25T12:00:00Z</start-valid-time>
  <start-valid-time>2003-10-25T15:00:00Z</start-valid-time>
  <start-valid-time>2003-10-25T18:00:00Z</start-valid-time>
  <start-valid-time>2003-10-25T21:00:00Z</start-valid-time>
  <start-valid-time>2003-10-26T00:00:00Z</start-valid-time>
  <start-valid-time>2003-10-26T03:00:00Z</start-valid-time>
  <start-valid-time>2003-10-26T06:00:00Z</start-valid-time>
  <start-valid-time>2003-10-26T09:00:00Z</start-valid-time>
  <start-valid-time>2003-10-26T12:00:00Z</start-valid-time>
  <start-valid-time>2003-10-26T15:00:00Z</start-valid-time>
  <start-valid-time>2003-10-26T18:00:00Z</start-valid-time>
  <start-valid-time>2003-10-26T21:00:00Z</start-valid-time>
  <start-valid-time>2003-10-27T00:00:00Z</start-valid-time>
  <start-valid-time>2003-10-27T06:00:00Z</start-valid-time>
  <start-valid-time>2003-10-27T12:00:00Z</start-valid-time>
</time-layout>
<time-layout time-coordinate="UTC" summarization="none">
  <layout-key>k-p6h-n11-4</layout-key>
  <start-valid-time>2003-10-24T18:00:01Z</start-valid-time>
  <end-valid-time>2003-10-25T00:00:00Z</end-valid-time>
  <start-valid-time>2003-10-25T00:00:01Z</start-valid-time>
  <end-valid-time>2003-10-25T06:00:00Z</end-valid-time>
  <start-valid-time>2003-10-25T06:00:01Z</start-valid-time>
  <end-valid-time>2003-10-25T12:00:00Z</end-valid-time>
  <start-valid-time>2003-10-25T12:00:01Z</start-valid-time>
  <end-valid-time>2003-10-25T18:00:00Z</end-valid-time>
  <start-valid-time>2003-10-25T18:00:01Z</start-valid-time>
  <end-valid-time>2003-10-26T00:00:00Z</end-valid-time>
  <start-valid-time>2003-10-26T00:00:01Z</start-valid-time>

```

```

<end-valid-time>2003-10-26T06:00:00Z</end-valid-time>
<start-valid-time>2003-10-26T06:00:01Z</start-valid-time>
<end-valid-time>2003-10-26T12:00:00Z</end-valid-time>
<start-valid-time>2003-10-26T12:00:01Z</start-valid-time>
<end-valid-time>2003-10-26T18:00:00Z</end-valid-time>
<start-valid-time>2003-10-26T18:00:01Z</start-valid-time>
<end-valid-time>2003-10-27T00:00:00Z</end-valid-time>
<start-valid-time>2003-10-27T00:00:01Z</start-valid-time>
<end-valid-time>2003-10-27T06:00:00Z</end-valid-time>
<start-valid-time>2003-10-27T06:00:01Z</start-valid-time>
<end-valid-time>2003-10-27T12:00:00Z</end-valid-time>
</time-layout>
<time-layout time-coordinate="UTC" summarization="none">
  <layout-key>k-p12h-n5-5</layout-key>
  <start-valid-time>2003-10-25T00:00:01Z</start-valid-time>
  <end-valid-time>2003-10-25T12:00:00Z</end-valid-time>
  <start-valid-time>2003-10-25T12:00:01Z</start-valid-time>
  <end-valid-time>2003-10-26T00:00:00Z</end-valid-time>
  <start-valid-time>2003-10-26T00:00:01Z</start-valid-time>
  <end-valid-time>2003-10-26T12:00:00Z</end-valid-time>
  <start-valid-time>2003-10-26T12:00:01Z</start-valid-time>
  <end-valid-time>2003-10-27T00:00:00Z</end-valid-time>
  <start-valid-time>2003-10-27T00:00:01Z</start-valid-time>
  <end-valid-time>2003-10-27T12:00:00Z</end-valid-time>
</time-layout>
<time-layout time-coordinate="UTC" summarization="none">
  <layout-key>k-p6h-n10-6</layout-key>
  <start-valid-time>2003-10-24T18:00:01Z</start-valid-time>
  <end-valid-time>2003-10-25T00:00:00Z</end-valid-time>
  <start-valid-time>2003-10-25T00:00:01Z</start-valid-time>
  <end-valid-time>2003-10-25T06:00:00Z</end-valid-time>
  <start-valid-time>2003-10-25T06:00:01Z</start-valid-time>
  <end-valid-time>2003-10-25T12:00:00Z</end-valid-time>
  <start-valid-time>2003-10-25T12:00:01Z</start-valid-time>
  <end-valid-time>2003-10-25T18:00:00Z</end-valid-time>
  <start-valid-time>2003-10-25T18:00:01Z</start-valid-time>
  <end-valid-time>2003-10-26T00:00:00Z</end-valid-time>
  <start-valid-time>2003-10-26T00:00:01Z</start-valid-time>
  <end-valid-time>2003-10-26T06:00:00Z</end-valid-time>
  <start-valid-time>2003-10-26T06:00:01Z</start-valid-time>
  <end-valid-time>2003-10-26T12:00:00Z</end-valid-time>
  <start-valid-time>2003-10-26T12:00:01Z</start-valid-time>
  <end-valid-time>2003-10-26T18:00:00Z</end-valid-time>
  <start-valid-time>2003-10-26T18:00:01Z</start-valid-time>
  <end-valid-time>2003-10-27T00:00:00Z</end-valid-time>
  <start-valid-time>2003-10-27T00:00:01Z</start-valid-time>
  <end-valid-time>2003-10-27T06:00:00Z</end-valid-time>
</time-layout>
<time-layout time-coordinate="UTC" summarization="none">
  <layout-key>k-p12h-n5-7</layout-key>
  <start-valid-time>2003-10-24T18:00:01Z</start-valid-time>
  <end-valid-time>2003-10-25T06:00:00Z</end-valid-time>
  <start-valid-time>2003-10-25T06:00:01Z</start-valid-time>
  <end-valid-time>2003-10-25T18:00:00Z</end-valid-time>
  <start-valid-time>2003-10-25T18:00:01Z</start-valid-time>
  <end-valid-time>2003-10-26T06:00:00Z</end-valid-time>

```

```

<start-valid-time>2003-10-26T06:00:01Z</start-valid-time>
<end-valid-time>2003-10-26T18:00:00Z</end-valid-time>
<start-valid-time>2003-10-26T18:00:01Z</start-valid-time>
<end-valid-time>2003-10-27T06:00:00Z</end-valid-time>
</time-layout>
<parameters applicable-location='point1'>
  <categorical-definitions>
    <categorical-table units="inches">
      <categorical-key>QPF-categories</categorical-key>
      <value category="no precipitation">0</value>
      <value category="0.01 to 0.09">1</value>
      <value category="0.10 to 0.24">2</value>
      <value category="0.25 to 0.49">3</value>
      <value category="0.50 to 0.99">4</value>
      <value category="1.00 to 1.99">5</value>
      <value category="2.00 inches or greater">6</value>
    </categorical-table>
    <categorical-table units="miles">
      <categorical-key>visibility-categories</categorical-key>
      <value category="less than or equal to 1/4">1</value>
      <value category="1/4 to 1/2">2</value>
      <value category="1/2 to 1">3</value>
      <value category="1 to 3">4</value>
      <value category="3 to 5">5</value>
      <value category="6">6</value>
      <value category="greater than 6">7</value>
    </categorical-table>
    <categorical-table units="feet">
      <categorical-key>ceiling-categories</categorical-key>
      <value category="less than 200">1</value>
      <value category="200 to 400">2</value>
      <value category="500 to 900">3</value>
      <value category="1000 to 3000">4</value>
      <value category="3100 to 6500">5</value>
      <value category="6600 to 12000">6</value>
      <value category="greater than 12000">7</value>
    </categorical-table>
  </categorical-definitions>
  <conversion-definitions>
    <conversion-table>
      <conversion-key>sky-cover</conversion-key>
      <start-value>0</start-value>
      <end-value>0</end-value>
      <equivalent-value>CL</equivalent-value>
      <start-value>3</start-value>
      <end-value>4</end-value>
      <equivalent-value>SC</equivalent-value>
      <start-value>5</start-value>
      <end-value>7</end-value>
      <equivalent-value>BK</equivalent-value>
      <start-value>8</start-value>
      <end-value>8</end-value>
      <equivalent-value>OV</equivalent-value>
    </conversion-table>
  </conversion-definitions>
  <temperature type="maximum" units="F" time-layout="k-p12h-n2-1">

```

```

    <name>Maximum Temperature</name>
    <value>62</value>
    <value>70</value>
</temperature>
<temperature type="minimum" units="F" time-layout="k-p12h-n3-2">
    <name>Minimum Temperature</name>
    <value>38</value>
    <value>57</value>
    <value>59</value>
</temperature>
<temperature type="temperature" units="F" time-layout="k-p12h-n21-3">
    <name>3 Hourly Temperature</name>
    <value>57</value>
    <value>57</value>
    <value>44</value>
    <value>41</value>
    <value>40</value>
    <value>40</value>
    <value>41</value>
    <value>55</value>
    <value>60</value>
    <value>60</value>
    <value>56</value>
    <value>58</value>
    <value>60</value>
    <value>60</value>
    <value>60</value>
    <value>65</value>
    <value>68</value>
    <value>67</value>
    <value>63</value>
    <value>64</value>
    <value>64</value>
</temperature>
<temperature type="dew point" units="F" time-layout="k-p12h-n21-3">
    <name>3 Hourly Dew Point Temperature</name>
    <value>27</value>
    <value>29</value>
    <value>36</value>
    <value>35</value>
    <value>35</value>
    <value>36</value>
    <value>39</value>
    <value>46</value>
    <value>49</value>
    <value>52</value>
    <value>54</value>
    <value>57</value>
    <value>59</value>
    <value>59</value>
    <value>59</value>
    <value>61</value>
    <value>61</value>
    <value>61</value>
    <value>60</value>
    <value>59</value>

```

```

    <value>60</value>
</temperature>
<cloud-amount type="total" units="8ths" time-layout="k-p3h-n21-3" conversion-table="sky-cover">
  <name>Total Sky Amount</name>
  <value>0</value>
  <value>0</value>
  <value>0</value>
  <value>0</value>
  <value>0</value>
  <value>0</value>
  <value>0</value>
  <value>6</value>
  <value>6</value>
  <value>6</value>
  <value>6</value>
  <value>6</value>
  <value>6</value>
  <value>8</value>
  <value>8</value>
  <value>8</value>
  <value>8</value>
  <value>8</value>
  <value>8</value>
  <value>8</value>
  <value>8</value>
  <value>8</value>
</cloud-amount>
<direction type="wind" units="degrees true" time-layout="k-p3h-n21-3">
  <name>10 Meter Wind Direction</name>
  <value>360</value>
  <value>0</value>
  <value>0</value>
  <value>0</value>
  <value>0</value>
  <value>0</value>
  <value>0</value>
  <value>190</value>
  <value>210</value>
  <value>0</value>
  <value>0</value>
  <value>200</value>
  <value>210</value>
  <value>210</value>
  <value>210</value>
  <value>210</value>
  <value>220</value>
  <value>220</value>
  <value>220</value>
  <value>180</value>
  <value>230</value>
</direction>
<wind-speed type="sustained" units="knots" time-layout="k-p3h-n21-3">
  <name>10 Meter Wind Speed</name>
  <value>2</value>
  <value>0</value>
  <value>0</value>
  <value>0</value>

```

```

<value>0</value>
<value>0</value>
<value>0</value>
<value>5</value>
<value>5</value>
<value>0</value>
<value>0</value>
<value>2</value>
<value>2</value>
<value>3</value>
<value>3</value>
<value>6</value>
<value>5</value>
<value>2</value>
<value>3</value>
<value>4</value>
<value>6</value>
</wind-speed>
<probability-of-precipitation type="6 hour" units="percent" time-layout="k-p6h-n11-4">
  <name>6 Hour Probability of Precipitation</name>
  <value>0</value>
  <value>0</value>
  <value>0</value>
  <value>3</value>
  <value>2</value>
  <value>11</value>
  <value>20</value>
  <value>32</value>
  <value>35</value>
  <value>20</value>
  <value>57</value>
</probability-of-precipitation>
<probability-of-precipitation type="12 hour" units="percent" time-layout="k-p12h-n5-5">
  <name>12 Hour Probability of Precipitation</name>
  <value>0</value>
  <value>10</value>
  <value>22</value>
  <value>59</value>
  <value>60</value>
</probability-of-precipitation>
<precipitation type="6 hour" time-layout="k-p6h-n11-4" categorical-table="QPF-categories">
  <name>6 Hour Precipitation</name>
  <value>0</value>
  <value>0</value>
  <value>0</value>
  <value>0</value>
  <value>0</value>
  <value>0</value>
  <value>0</value>
  <value>0</value>
  <value>0</value>
  <value>0</value>
  <value>0</value>
  <value>2</value>
</precipitation>
<precipitation type="12 hour" time-layout="k-p12h-n5-5" categorical-table="QPF-categories">
  <name>12 Hour Precipitation</name>

```

```

    <value>0</value>
    <value>0</value>
    <value>0</value>
    <value>1</value>
    <value>2</value>
</precipitation>
<probability-of-precipitation type="6 hour thunderstorm" units="percent" time-layout="k-p6h-n10-6">
  <name>6 Hour Probability of Thunderstorms</name>
  <value>0</value>
  <value>0</value>
  <value>0</value>
  <value>0</value>
  <value>0</value>
  <value>2</value>
  <value>3</value>
  <value>2</value>
  <value>6</value>
  <value>18</value>
</probability-of-precipitation>
<probability-of-precipitation type="12 hour thunderstorm" units="percent" time-layout="k-p12h-n5-7">
  <name>12 Hour Probability of Thunderstorms</name>
  <value>0</value>
  <value>0</value>
  <value>2</value>
  <value>5</value>
  <value>18</value>
</probability-of-precipitation>
<probability-of-precipitation type="6 hour severe thunderstorm" units="percent" time-layout="k-p6h-n10-6">
  <name>6 Hour Conditional Probability of Severe Thunderstorms</name>
  <value>24</value>
  <value>19</value>
  <value>0</value>
  <value>27</value>
  <value>19</value>
  <value>19</value>
  <value>0</value>
  <value>30</value>
  <value>25</value>
  <value>1</value>
</probability-of-precipitation>
<probability-of-precipitation type="12 hour severe thunderstorm" units="percent" time-layout="k-p12h-n5-7">
  <name>12 Hour Conditional Probability of Severe Thunderstorms</name>
  <value>29</value>
  <value>27</value>
  <value>32</value>
  <value>30</value>
  <value>40</value>
</probability-of-precipitation>
<probability-of-precipitation type="freezing" units="percent" time-layout="k-p3h-n21-3">
  <name>3 Hour Probability of Freezing Precipitation</name>
  <value>0</value>
  <value>0</value>
  <value>0</value>
  <value>0</value>
  <value>0</value>
  <value>0</value>

```



```

    <value xsd:nil="true" />
</weather-conditions>
<weather-conditions>
    <value>
        <visibility>7</visibility>
    </value>
    <value xsd:nil="true" />
</weather-conditions>
<weather-conditions>
    <value weather-type="rain">
        <visibility>7</visibility>
    </value>
    <value xsd:nil="true" />
</weather-conditions>
<weather-conditions>
    <value weather-type="rain">
        <visibility>7</visibility>
    </value>
    <value xsd:nil="true" />
</weather-conditions>
<weather-conditions>
    <value weather-type="rain">
        <visibility>7</visibility>
    </value>
    <value xsd:nil="true" />
</weather-conditions>
<weather-conditions>
    <value weather-type="rain">
        <visibility>7</visibility>
    </value>
    <value xsd:nil="true" />
</weather-conditions>
<weather-conditions>
    <value weather-type="rain">
        <visibility>7</visibility>
    </value>
    <value xsd:nil="true" />
</weather-conditions>
<weather-conditions>
    <value weather-type="rain">
        <visibility>7</visibility>
    </value>
    <value xsd:nil="true" />
</weather-conditions>
<weather-conditions>
    <value weather-type="rain">
        <visibility>7</visibility>
    </value>
    <value xsd:nil="true" />
</weather-conditions>
<weather-conditions>
    <value weather-type="rain">
        <visibility>7</visibility>
    </value>
    <value xsd:nil="true" />
</weather-conditions>
<weather-conditions>
    <value weather-type="rain">
        <visibility>7</visibility>
    </value>
    <value xsd:nil="true" />
</weather-conditions>

```

```

<weather-conditions>
  <value weather-type="rain">
    <visibility>6</visibility>
  </value>
  <value weather-type="haze" />
</weather-conditions>
<weather-conditions>
  <value weather-type="rain" />
  <value weather-type="fog">
    <visibility>3</visibility>
  </value>
</weather-conditions>
<weather-conditions>
  <value weather-type="rain">
    <visibility>2</visibility>
  </value>
  <value weather-type="haze" />
</weather-conditions>
<weather-conditions>
  <value weather-type="rain">
    <visibility>6</visibility>
  </value>
  <value weather-type="haze" />
</weather-conditions>
<weather-conditions>
  <value weather-type="rain">
    <visibility>7</visibility>
  </value>
  <value>none</value>
</weather-conditions>
<weather-conditions>
  <value weather-type="rain">
    <visibility>7</visibility>
  </value>
  <value>none</value>
</weather-conditions>
<weather-conditions>
  <value weather-type="rain">
    <visibility>7</visibility>
  </value>
  <value>none</value>
</weather-conditions>
<weather-conditions>
  <value weather-type="rain">
    </value>
  <value weather-type="fog" />
</weather-conditions>
<visibility>1</visibility>
<weather-conditions>
  <value weather-type="rain">
    <visibility>4</visibility>
  </value>
  <value weather-type="haze" />
</weather-conditions>
</weather>
<cloud-amount type="ceiling" units="none" time-layout="k-p3h-n21-3" categorical-table="ceiling-categories">

```

```
<name>ceiling</name>
<value>7</value>
<value>7</value>
<value>7</value>
<value>7</value>
<value>7</value>
<value>7</value>
<value>7</value>
<value>7</value>
<value>7</value>
<value>5</value>
<value>5</value>
<value>5</value>
<value>7</value>
<value>5</value>
<value>5</value>
<value>4</value>
<value>4</value>
<value>4</value>
<value>5</value>
<value>5</value>
<value>4</value>
<value>3</value>
</cloud-amount>
</parameters>
</data>
</dwml>
```

Appendix E: Type Definitions

dwmlType (scope = global, element only)

attribute = version, type = string, default = "1.0"

choice

sequence

element = head, type = headType, min = 1, max = 1

element = data, type = dataType, min = 1, max = 1

sequence

element=latLonList, type= latLonListType, min = 1, max = 1

headType (scope = global, element only)

sequence

element = product, type productType, min = 1, max = 1

element = source, type sourceType, min = 0, max = 1

productType (scope = global, element only)

attribute = concise-name, type = concise-nameType, use = required

attribute = srsName, type = srsNameType, use = required

attribute = operational-mode, type = operational-modeType, use = required

anyOrder

element = title, type = string, min = 0, max = 1

element = field, type = fieldType, , min = 0, max = 1

element = category, type = categoryType, min = 0, max = 1

element = creation-date, type = creation-dateType, , min = 1, max = 1

fieldType (scope = local, base = string)

enumeration

"meteorological"

categoryType (scope = local, base = string)

enumeration

"forecastl"

concise-nameType (scope = local, base = string)

enumeration

"time-series" "glance" "tabular-digital" "digital-zone" "dwmlByDay"

operational-modeType (scope = local, base = string)

enumeration

"test" "developmental" "experimental" "official"

srsNameType (scope = local, base = string)

enumeration

“WGS 1984”

creation-dateType (scope = local, text only with base = dateTime)

attribute = refresh-frequency, type = duration, use = required

sourceType (scope = local, element only)

anyOrder

element = more-information, type = anyURI, min = 1, max = 1

element = production-center, type = production-centerType, min = 0, max = 1

element = disclaimer, type = anyURI, min = 0, max = 1

element = credit, type = anyURI, min = 0, max = 1

element = credit-logo, type = anyURI, min = 0, max = 1

element = feedback, type = anyURI, min = 0, max = 1

production-centerType (scope = local, mixed text and element)

element = sub-center, type = string, min = 0, max = 1

dataType (scope = local, element only)

sequence

element = location, type = locationType, min = 1, max = unbounded

element = time-layout, type = time-layoutType, min = 1, max = unbounded

element = parameters, type = parametersType, min = 1, max = unbounded

locationType (scope = local, element only)

element = location-key, type = string, min = 1, max = 1

element = description, type = string, min = 0, max = 1

choice

element = point, type = pointType, min = 0, max = 1

element = nws-zone, type = nws-zoneType, min = 0, max = 1

element = area, type = areaType, min = 0, max = 1

element = city, type = cityType, min = 0, max = 1

choice

element = height, type = heightType, min = 0, max = 1

element = level, type = levelType, min = 0, max = 1

element = layer, type = layerType, min = 0, max = 1

location-keyType (scope = local to data element, text only with base = string)

must be unique

pointType (scope = location element, element only)

attribute = summarization, type = summarizationType, use = optional

attribute = latitude, type = decimal, use = required

attribute = longitude, type = decimal, use = required

cityType (scope = local, text only with base = string)

attribute = state, type = stateType, use = required

attribute = summarization, type = summarizationType, use = optional

stateType (scope = location element, base = string)

pattern

[A-Z][A-Z] (only two digits allowed)

nws-zoneType (scope = local, text only with base = string)

attribute = state, type = stateType, use = required

attribute = summarization, type = summarizationType, use = optional

summarizationType (scope = data element, base = string)

enumeration

“mean” “medium” “mode” “maximum” “minimum” “12hourly” “24hourly” “none”

areaType (scope = local, element only)

attribute = area-type, type = area-typeType, use = required

choice

element = circle, type = circleType, min = 0, max = 1

element = rectangle, type = rectangleType, min = 0, max = 1

area-typeType (scope = local, base = string)

enumeration

“circle” “rectangle”

circleType (scope = local, element only)

attribute = summarization, type = summarizationType, use = optional

element = point, type = pointType, min = 1, max = 1

element = radius, type = radiusType, min = 1, max = 1

radiusType (scope = local, base = decimal)

attribute = radius-units, type=radius-unitsType, use = required

radius-unitsType (scope = local, base = string)

enumeration

“statute miles” “kilometers”

rectangleType (scope = local, element only)

attribute = summarization, type = summarizationType, use = optional

element = point, type = pointType, min = 4, max = 4

heightType (scope = local, base = decimal)

attribute = datum, type = datumType, use = required

attribute = height-units, type = height-unitsType, use = required

datumType (scope = local, base = string)

enumeration

“surface” “mean sea level”

height-unitsType (scope = local, base = string)

enumeration

“feet” “meters”

levelType (scope = local, base = nonNegativeInteger)

attribute = vertical-coordinate, type = string, use = optional

layerType (scope = local, base = nonNegativeInteger)

attribute = vertical-coordinate, type = vertical-coordinateType, use = optional

time-layoutType (scope = local, element only)

attribute = time-coordinate, type = time-coordinateType, use = required

attribute = summarization; type = summarizationType, use = optional

sequence

element = layout-key, type = layout-keyType, min = 1, max = unbounded

sequence

element = start-valid-time, type = start-valid-timeType, min = 1, max = unbounded

element = end-valid-time, type = dateTime, min = 0, max = unbounded

time-coordinateType (scope = local, base = string)

enumeration

“local time” “UTC”

layout-keyType (scope = local, base = string)

pattern

k-p\d+[h|d|m|y]-n\d+-\d+ (something like k-p12h-n10-1)

must be unique

start-valid-timeType (scope = local, base = dateTime)

attribute = period-name, type = string, use = optional

parametersType (scope = local, element only)

attribute = applicable-location, type = string, use = required

anyOrder

element = temperature, type = temperatureType, min = 0, max = unbounded

element = precipitation, type = precipitationType, min = 0, max = unbounded

element = probability-of-precipitation, type = probability-of-precipitationType,
min = 0, max = unbounded

element = convective-hazard, type = convective-hazardType,
min = 0, max = unbounded

element = wind-speed, type = wind-speedType, min = 0, max = unbounded

element = direction, type = directionType, min = 0, max = unbounded

element = cloud-amount, type = cloud-amountType, min = 0, max = unbounded

element = weather, type = weatherType, min = 0, max = unbounded

element = humidity, type = humidityType, min = 0, max = unbounded
element = conditions-icon, type = conditions-iconType, min = 0, max = unbounded
element = wordedForecast, type = wordedForecastType, min = 0, max = unbounded
element = water-state, type = conditions-iconType, min = 0, max = unbounded

temperatureType (scope = local, element only)

attribute = type, type = typeType, use = required

attribute = units, type = string, fixed = "F"

attribute = time-layout, type = time-layoutType, use = required

attribute = categorical-table, type = string, use = optional

attribute = conversion-table, type = string, use = optional

sequence

element = name, type = string, min = 0, max = 1

choice

element = value, type = valueType, min = 1, max = unbounded, nillable

element = valueWithUncertainty, type = valueWithUncertaintyType, min = 1, max = unbounded, nillable

typeType (scope = local, base = string)

enumeration

"maximum" "minimum" "hourly" "dew point" "heat index" "wind chill" "apparent"

"monthly anomalies" "seasonal anomalies" "8-14 day anomalies" "monthly anomalies"

"seasonal anomalies" "rtma-hourly" "rtma-dew point"

valueWithUncertaintyType (scope = local, element only)

sequence

element = value, type = valueType, min = 0, max = 1, nillable

element = error, type = errorType, min = 0, max = 1, nillable

errorType (scope = local, base = decimal)

attribute = qualifier, type = qualifierType, use = optional

qualifierType (scope = local, base = string)

enumeration

" +/-", "+", "-", "%"

valueTypeType (scope = local, base = string)

enumeration

"RTMA" "NDFD"

time-layoutType (scope = element parameters, base = string)

pattern

k-p\d+[h\d|m|y]-n\d+-\d+ (something like k-p12h-n10-1)

must match one layout-key element content

valueType (scope = local, base = integer)

attribute = type, type = valueType, use = optional
attribute = upper-range, type = upper-rangeType, use = optional
attribute = lower-range, type = lower-rangeType, use = optional
minInclusive = -459

upper-rangeType (scope = local, base = integer)
minInclusive = -459

lower-rangeType (scope = local, base = integer)
minInclusive = -459

precipitationType (scope = local, element only)
attribute = type, type = typeType, use = required
attribute = units, type = string, fixed = "inches"
attribute = time-layout, type = time-layoutType, use = required
attribute = categorical-table, type = string, use = optional
attribute = conversion-table, type = string, use = optional
sequence
 element = name, type = string, min = 0, max = 1
 element = value, type = valueType, min = 1, max = unbounded, nillable

typeType (scope = local, base = string)
enumeration
 "liquid" "snow" "8-14 day anomalies" "monthly anomalies" "seasonal anomalies"
 "rtma-liquid"

valueType (scope = local, base = nonNegativeInteger)
attribute = upper-range, type = nonNegativeInteger, use = optional
attribute = lower-range, type = nonNegativeInteger, use = optional

probability-of-precipitationType (scope = local, element only)
attribute = type, type = typeType, default = "12 hour"
attribute = units, type = string, fixed = "percent"
attribute = time-layout, type = time-layoutType, use = required
attribute = categorical-table, type = string, use = optional
attribute = conversion-table, type = string, use = optional
sequence
 element = name, type = string, min = 0, max = 1
 element = value, type = valueType, min = 1, max = unbounded, nillable

typeType (scope = local, base = string)
enumeration
 "12 hour" "floating"

convective=hazardType (scope = local, element only)
attribute = type, type = typeType

attribute = units, type = string, fixed = "percent"
attribute = time-layout, type = time-layoutType, use = required
attribute = categorical-table, type = string, use = optional
attribute = conversion-table, type = string, use = optional
sequence
 element = name, type = string, min = 0, max = 1
 element = value, type = valueType, min = 1, max = unbounded, nillable

typeType (scope = local, base = string)

enumeration

 "outlook" "tornadoes" "hail" "damaging thunderstorm winds" "extreme tornadoes" "extreme hail" "extreme thunderstorm winds" "severe thunderstorms" "extreme severe thunderstorms"

valueType (scope = local, base = nonNegativeInteger)

attribute = upper-range, type = upper-rangeType, use = optional
attribute = lower-range, type = lower-rangeType, use = optional
maxInclusive = 100

upper-rangeType (scope = local, base = nonNegativeInteger)

maxInclusive = 100

lower-rangeType (scope = local, base = nonNegativeInteger)

maxInclusive = 100

wind-speedType (scope = local, element only)

attribute = type, type = typeType, use = required
attribute = units, type = unitsType, default = "knots"
attribute = time-layout, type = time-layoutType, use = required
attribute = categorical-table, type = string, use = optional
attribute = conversion-table, type = string, use = optional
sequence
 element = name, type = string, min = 0, max = 1
 choice
 element = value, type = valueType, min = 1, max = unbounded, nillable
 element = valueWithUncertainty, type = valueWithUncertainty Type, min = 1, max = unbounded, nillable

typeType (scope = local, base = string)

enumeration

 "sustained" "gust" "transport" "cumulative34" "cumulative50" "cumulative64"
 "incremental34" "incremental50" "incremental64" "rtma-sustained"

unitsType (scope = local, base = string)

enumeration

 "knots" "percent"

valueType (scope = local, base = nonNegativeInteger)
attribute = type, type = valueTypeType, use = optional
attribute = upper-range, type = nonNegativeInteger, use = optional

valueWithUncertaintyType (scope = local, element only)
sequence
element = value, type = valueType, min = 0, max = 1, nillable
element = error, type = errorType, min = 0, max = 1, nillable

errorType (scope = local, base = decimal)
attribute = qualifier, type = qualifierType, use = optional

qualifierType (scope = local, base = string)
enumeration
“+/-“, “+”, “-“, “%”

valueTypeType (scope = local, base = string)
enumeration
“RTMA” “NDFD”

directionType (scope = local to parameters element, element only)
attribute = type, type = typeType, default = “wind”
attribute = units, type = string, fixed = “degrees true”
attribute = time-layout, type = time-layoutType, use = required
attribute = categorical-table, type = string, use = optional
attribute = conversion-table, type = string, use = optional
sequence
element = name, type = string, min = 0, max = 1
choice
element = value, type = valueType, min = 1, max = unbounded, nillable
element = valueWithUncertainty, type = valueWithUncertainty Type, min = 1, max = unbounded, nillable

typeType (scope = local, base = string)
enumeration
“wind” “swell”

valueWithUncertaintyType (scope = local, element only)
sequence
element = value, type = valueType, min = 0, max = 1, nillable
element = error, type = errorType, min = 0, max = 1, nillable

errorType (scope = local, base = decimal)
attribute = qualifier, type = qualifierType, use = optional

qualifierType (scope = local, base = string)

enumeration
“+/-“, “+”, “-“, “%”

valueTypeType (scope = local, base = string)

enumeration
“RTMA” “NDFD”

valueType (scope = local, base = nonNegativeInteger)

attribute = type, type = valueTypeType, use = optional
maxInclusive = 360

cloud-amountType (scope = local, element only)

attribute = type, type = string, fixed = “total”
attribute = units, type = string, fixed = “percent”
attribute = time-layout, type = time-layoutType, use = required
attribute = categorical-table, type = string, use = optional
attribute = conversion-table, type = string, use = optional
sequence
 element = name, type = string, min = 0, max = 1
 sequence
 element = layer, type = layerType, min = 0, max = 0
 element = value, type = valueType, min = 1, max = unbounded, nillable

NOTE: conversion-table values for sky cover can be found in Table 2.

valueType (scope = local, base = nonNegativeInteger)

attribute = upper-range, type = upper-rangeType, use = optional
attribute = lower-range, type = lower-rangeType, use = optional
maxInclusive = 100

upper-rangeType (scope = local, base = nonNegativeInteger)

maxInclusive = 100

lower-rangeType (scope = local, base = nonNegativeInteger)

maxInclusive = 100

weatherType (scope = local, element only)

attribute = time-layout, type = time-layoutType, use = required
element = weather-conditions, type = weather-conditionsType, min = 1, max = unbounded, nillable

weather-conditionsType (scope = local, element only)

element = value, type = valueType, min = 1, max = unbounded, nillable
attribute = categorical-table, type = string, use = optional
attribute = conversion-table, type = string, use = optional
attribute = weather-summary, type = string, use = optional

valueType (scope = local, elements only)
attribute = coverage, type = coverageType, use = optional
attribute = intensity, type = intensityType, use = optional
attribute = additive, type = additiveType, use = optional
attribute = weather-type, type = weather-typeType, use = optional
attribute = qualifier, type = qualifierType, use = optional
element = visibility, type = visibilityType, min = 0, max = 1, nillable

coverageType (scope = local, base = string)
enumeration
See Table 3 for valid values

intensityType (scope = local, base = string)
enumeration
See Table 4 for valid values

additiveType (scope = local, base = string)
enumeration
“and” “or”

visibilityType (scope = local, base = string)
attribute = visibility-units, type = visibility-unitsType, default = “statute miles”
enumeration
See Table 7 for valid values

visibility-unitsType (scope = local, base = string)
Enumeration
“statute miles” “nautical miles”

qualifierType (scope = local, base = string)
pattern (comma delimited string)
See Table 6, for valid values

weather-typeType (scope = local, base = string)
enumeration
See Table 5, for valid values

humidityType (scope = local, element only)
attribute = type, type = typeType, default = “relative”
attribute = units, type = string, fixed = “percent”
attribute = time-layout, type = time-layoutType, use = required
attribute = categorical-table, type = string, use = optional
attribute = conversion-table, type = string, use = optional
sequence
element = name, type = string, min = 0, max = 1
element = value, type = valueType, min = 1, max = unbounded, nillable

typeType (scope = local, base = string)
enumeration
“relative” “max relative” “min relative”

valueType (scope = local, base = nonNegativeInteger)
attribute = upper-range, type = upper-rangeType, use = optional
attribute = lower-range, type = lower-rangeType, use = optional
maxInclusive = 100

upper-rangeType (scope = local, base = nonNegativeInteger)
maxInclusive = 100

lower-rangeType (scope = local, base = nonNegativeInteger)
maxInclusive = 100

conditions-iconType (scope = local, element only)
attribute = type, type = typeType, default = “forecast-NWS”
attribute = time-layout, type = time-layoutType, use = required
sequence
element = name, type = string, min = 0, max = 1
element = icon-link, type = anyURI, min = 1, max = unbounded

NOTE: The priority algorithm for icon determination can be found in Table 8 - Table 11. In these tables, the nomenclature [20,30...90,100] indicates that one of the 2 digit values appear in the icon file name. For example, the rain icon could be ra20.jpg, ra30.jpg on up to ra100.jpg.

typeType (scope = local, base = string)
enumeration
“forecast-NWS”

categorical-definitions (scope = local to parameter element, element only)
element = categorical-table, type = categorical-tableType, min = 1, max = unbounded

categorical-table-elementType (scope = local, element only)
attribute = units, type = string, use = required
element = categorical-key, type = key, min = 1, max = 1
element = value, type = valueType, min = 1, max = unbounded

valueType (scope = local, text only)
attribute = category, type = string, use = required

conversion-definitions (scope = local to parameter element, element only)
element = categorical-table, type = categorical-tableType, min = 1, max = unbounded

conversion-table-elementType (scope = local, element only)

attribute = units, type = string, use = required

sequence

element = conversion-key, type = key, min = 1, max = 1

sequence

element = start-value, type = anyType, min = 1, max = unbounded

element = start-value, type = anyType, min = 1, max = unbounded

element = equivalence-value, type = string, min = 1, max = unbounded

wordedForecastType (scope = local, element only)

attribute = time-layout, type = time-layoutType, use = required

attribute = dataSource, type = string, use = optional

attribute = wordGenerator, type = string, use = optional

sequence

element = name, type = string, min = 0, max = 1

element = text, type = string, min = 1, max = unbounded

water-state (scope = local, element only)

attribute = time-layout, type = time-layoutType, use = required

choice

sequence

element = waves, type = wavesType, min = 0, max = unbounded

element = swell, type = swellType, min = 0, max = unbounded

element = seas, type = seasType, min = 0, max = unbounded

element = ice-coverage, type = ice-coverageType, min = 0, max = unbounded

waveType (scope = local, element only)

attribute = type, type = string, default = "wind"

attribute = units, type = string, fixed = "feet"

attribute = categorical-table, type = string, use = optional

attribute = conversion-table, type = string, use = optional

attribute = period, type = nonNegativeInteger, use = optional

attribute = steepness, type = nonNegativeInteger, use = optional

sequence

element = name, type = string, min = 0, max = 1

element = value, type = nonNegativeInteger, min = 1, max = unbounded, nillable

swellType (scope = local, element only)

attribute = type, type = string, default = "none"

attribute = units, type = string, fixed = "feet"

attribute = categorical-table, type = string, use = optional

attribute = conversion-table, type = string, use = optional

attribute = period, type = nonNegativeInteger, use = optional

attribute = steepness, type = nonNegativeInteger, use = optional

sequence

element = name, type = string, min = 0, max = 1

sequence

element = value, type = nonNegativeInteger, min = 1, max = unbounded, nillable
 element = direction, type = directionType, min = 0, max = unbounded, nillable

seasType (scope = local, element only)

attribute = type, type = string, default = “combined”
 attribute = units, type = string, fixed = “feet”
 attribute = categorical-table, type = string, use = optional
 attribute = conversion-table, type = string, use = optional
 sequence
 element = name, type = string, min = 0, max = 1
 element = value, type = nonNegativeInteger, min = 1, max = unbounded, nillable

ice-coverageType (scope = local, element only)

attribute = type, type = string, default = “total”
 attribute = units, type = string, fixed = “percent”
 attribute = categorical-table, type = string, use = optional
 attribute = conversion-table, type = string, use = optional
 sequence
 element = name, type = string, min = 0, max = 1
 element = value, type = nonNegativeInteger, min = 1, max = unbounded, nillable

latLonListType (scope = local, base = string)

pattern (space delimited string of latitude and longitude pairs)

Total Sky Cover Values (<i><value></i>)	Text Equivalent (<i>equivalent-value</i>)
Sky Cover <= 5 percent	clear
5 percent < Sky Cover <= 25 percent	mostly clear
25 percent < Sky Cover <= 50 percent	partly cloudy
50 percent < Sky Cover <= 87 percent	mostly cloudy
87 percent < Sky Cover <= 100percent	cloudy

Table 2: Sky Cover to Text Conversion (Source: NWSI 10-503).

Coverage Values (<i>weather-coverage</i>)			
slight chance	occasional	scattered	areas
chance	definitely	numerous	widespread

likely	isolated	patchy	none
--------	----------	--------	------

Table 3: Valid Values for Weather Coverage Attribute.

Intensity Values (<i>weather-intensity</i>)	Intensity Values (<i>weather-intensity</i>)
very light	heavy
light	none
moderate	

Table 4: Valid Values for Weather Intensity.

Weather Values (<i><value></i>)	Weather Values (<i><value></i>)
freezing drizzle	thunderstorms
freezing rain	drizzle
snow shower	fog
blowing snow	haze
blowing dust	blowing sand
rain shower	ice crystals
ice pellets	volcanic ash
frost	water spouts
rain	freezing fog
hail	ice fog
snow	freezing spray
smoke	none

Table 5: Valid Weather Values.

Weather Attributes (<i>weather-qualifier</i>)	Weather Attributes (<i>weather-qualifier</i>)
frequent lightning	gusty winds

Weather Attributes (<i>weather-qualifier</i>)	Weather Attributes (<i>weather-qualifier</i>)
heavy rain	damaging winds
small hail	large hail
outlying areas	on bridges and overpasses
on grassy areas	or
dry	highest ranking
include unconditionally	tornado
mixture	none

Table 6: Valid Weather Attributes.

Visibility Values (<i><visibility></i>)		
0	1 ½	5
¼	2	6
½	2 ½	6+
¾	3	none
1	4	

Table 7: Valid Visibility Values.

Weather Condition	Index of icons found at: http://www.weather.gov/weather/images/fcicons/
IC	no icon
VA	no icon
WP	no icon
ZY	no icon
FR	no icon
T AND (sky > 60)	ntsra[20,30...90,100].jpg

Weather Condition	Index of icons found at: http://www.weather.gov/weather/images/fcicons/
T AND (sky <= 60)	nscttsra[20,30...90,100].jpg
(S OR SW) AND IP	ip[20,30...90,100].jpg
(R OR RW OR L) AND IP	nraip[20,30...90,100].jpg
(ZR OR ZL) AND (S OR SW OR IP)	mix[20,30...90,100].jpg
(R OR RW OR L) AND (S OR SW)	nrasn[20,30...90,100].jpg
S OR SW	nnsn[20,30...90,100].jpg
ZR OR ZL	fzra[20,30...90,100].jpg
IP	ip[20,30...90,100].jpg
RW AND (sky > 60)	nra[20,30...90,100].jpg
RW AND (sky <= 60)	hi_nshwrs[20,30...90,100].jpg
L OR R	nra[20,30...90,100].jpg
BS	blizzard.jpg
BD OR BN	du.jpg
H	no icon
K	fu.jpg
F OR ZF OR IF	nfg.jpg
(wind > 25)	nwind.jpg
(sky > 94)	novc.jpg
(sky > 69)	nbkn.jpg
(sky > 31)	nsct.jpg
(sky > 6)	nfew.jpg
default	nskc.jpg

Table 8: NDFDgen Night Time Icon Algorithm (priority in ascending order).

Weather Condition	Index of icons found at: http://www.weather.gov/weather/images/fcicons/
--------------------------	--

Weather Condition	Index of icons found at: http://www.weather.gov/weather/images/fcicons/
IC	no icon
VA	no icon
WP	no icon
ZY	no icon
FR	no icon
T AND (sky > 60)	tsra[20,30...90,100].jpg
T AND (sky <= 60)	scttsra[20,30...90,100].jpg
(S OR SW) AND IP	ip[20,30...90,100].jpg
(R OR RW OR L) AND IP	raip[20,30...90,100].jpg
(ZR OR ZL) AND (S OR SW OR IP)	mix[20,30...90,100].jpg
(R OR RW OR L) AND (S OR SW)	rasn[20,30...90,100].jpg
(S OR SW)	sn[20,30...90,100].jpg
(ZR OR ZL)	fzra.jpg
IP	ip[20,30...90,100].jpg
RW AND (sky > 60)	shra[20,30...90,100].jpg
RW AND (sky <= 60)	hi_shwrs[20,30...90,100].jpg
L OR R	ra[20,30...90,100].jpg
BS	blizzard.jpg
BD OR BN	du.jpg
H	no icon
K	fu.jpg
F OR ZF OR IF	fg.jpg
(temp < -40)	cold.jpg
(temp > 110)	hot.jpg
(wind > 25)	wind.jpg
(sky > 94)	ovc.jpg

Weather Condition	Index of icons found at: http://www.weather.gov/weather/images/fcicons/
(sky > 69)	bkn.jpg
(sky > 31)	sct.jpg
(sky > 6)	few.jpg
default	skc.jpg

Table 9: NDFDgen Day Time Icon Algorithm (priority in ascending order).

Weather Condition	Index of icons found at: http://www.weather.gov/weather/images/fcicons/
IC	no icon
VA	no icon
WP	no icon
ZY	no icon
FR	no icon
T AND (PoP >= 10) AND (sky > 60)	ntsra[20,30...90,100].jpg
T AND (PoP >= 10) AND (sky <= 60)	nscttsra[20,30...90,100].jpg
IP AND (S OR SW) AND (PoP >= 20)	ip[20,30...90,100].jpg
IP AND (R OR RW) AND (PoP >= 20)	nraip[20,30...90,100].jpg
IP AND (ZL OR ZR) AND (PoP >= 20)	mix[20,30...90,100].jpg
(R OR RW) AND (ZL OR ZR) AND (PoP >= 20)	fzra[20,30...90,100].jpg
(ZR OR ZL) AND (S OR SW) AND (PoP >= 20)	mix[20,30...90,100].jpg
ZL AND (PoP >= 20)	fzra[20,30...90,100].jpg
ZR AND (PoP >= 20)	fzra[20,30...90,100].jpg
(R OR RW) AND (S OR SW) AND (PoP >= 20)	nrasn[20,30...90,100].jpg
S AND (PoP >= 20)	nsn[20,30...90,100].jpg
(S OR SW) AND (PoP >= 20) AND (Int = '--')	nsn[20,30...90,100].jpg
SW AND (PoP >= 20) AND (Int != '--') AND (sky <= 60)	nsn[20,30...90,100].jpg

Weather Condition	Index of icons found at: http://www.weather.gov/weather/images/fcicons/
SW AND (PoP >= 20) AND (Int != '--') AND (sky > 60)	nsn[20,30...90,100].jpg
L AND (PoP >= 20)	nra[20,30...90,100].jpg
R AND (PoP >= 20)	nra[20,30...90,100].jpg
RW AND (PoP >= 20) AND (sky <= 60)	nra[20,30...90,100].jpg
RW AND (PoP >= 20) AND (sky > 60)	hi_nshwrs[20,30...90,100].jpg
IP AND (PoP >= 20)	ip[20,30...90,100].jpg
K	fu.jpg
ZF	nfg.jpg
IF	nfg.jpg
H	no icon
BN	du.jpg
BD	du.jpg
BS	blizzard.jpg
F	nfg.jpg
(wind >= 15)	nwind.jpg
(sky <= 101)	novc.jpg
(sky <= 90)	nbkn.jpg
(sky <70)	nsct.jpg
(sky <40)	nfew.jpg
(sky <= 15)	nskc.jpg

Table 10: NDFDgenByDay Night Time Icon Algorithm (format = '12 hourly') (priority in ascending order).

Weather Condition	Index of icons found at: http://www.weather.gov/weather/images/fcicons/
IC	no icon
VA	no icon

Weather Condition	Index of icons found at: http://www.weather.gov/weather/images/fcicons/
WP	no icon
ZY	no icon
FR	no icon
T AND (PoP >= 10) AND (sky > 60)	tsra[20,30...90,100].jpg
T AND (PoP >= 10) AND (sky <= 60)	scttsra[20,30...90,100].jpg
IP AND (S OR SW) AND (PoP >= 20)	ip[20,30...90,100].jpg
IP AND (R OR RW) AND (PoP >= 20)	raip[20,30...90,100].jpg
IP AND (ZL OR ZR) AND (PoP >= 20)	mix[20,30...90,100].jpg
(R OR RW) AND (ZL OR ZR) AND (PoP >= 20)	fzra[20,30...90,100].jpg
(ZR OR ZL) AND (S OR SW) AND (PoP >= 20)	mix[20,30...90,100].jpg
ZL AND (PoP >= 20)	fzra[20,30...90,100].jpg
ZR AND (PoP >= 20)	fzra[20,30...90,100].jpg
(R OR RW) AND (S OR SW) AND (PoP >= 20)	rasn[20,30...90,100].jpg
S AND (PoP >= 20)	sn[20,30...90,100].jpg
(S OR SW) AND (PoP >= 20) AND (Int = '--')	sn[20,30...90,100].jpg
SW AND (PoP >= 20) AND (Int != '--') AND (sky <= 60)	sn[20,30...90,100].jpg
SW AND (PoP >= 20) AND (Int != '--') AND (sky > 60)	sn[20,30...90,100].jpg
L AND (PoP >= 20)	ra[20,30...90,100].jpg
R AND (PoP >= 20)	ra[20,30...90,100].jpg
RW AND (PoP >= 20) AND (sky <= 60)	shra[20,30...90,100].jpg
RW AND (PoP >= 20) AND (sky > 60)	hi_shwrs[20,30...90,100].jpg
IP AND (PoP >= 20)	ip[20,30...90,100].jpg
K	fu.jpg
ZF	fg.jpg
IF	fg.jpg
H	no icon

Weather Condition	Index of icons found at: http://www.weather.gov/weather/images/fcicons/
BN	du.jpg
BD	du.jpg
BS	blizzard.jpg
F	fg.jpg
(wind >= 15)	wind.jpg
(MaxT < 32)	cold.jpg
(MaxT > 95)	hot.jpg
(sky <= 101)	ovc.jpg
(sky <= 90)	bkn.jpg
(sky <70)	sct.jpg
(sky <40)	few.jpg
(sky <= 15)	skc.jpg

Table 11: NDFDgenByDay Day Time Icon Algorithm (format = '12 hourly' or '24 hourly) (priority in ascending order).

Weather Condition	Weather Summary Phrase
IC	if \$coverage = "patchy" OR "areas" --> "\$coverage Ice Crystals" else --> "Ice Crystals"
VA	Volcanic Ash
WP	Water Spout
ZY	Freezing Spray
FR	if \$coverage = "patchy" OR "areas" --> "\$coverage Frost" else --> "Frost"
T AND (PoP >= 10) AND (sky > 60)	if \$coverage = "chance" OR "slight chance" --> "Chance Thunderstorms" else if \$coverage = "likely" --> "Thunderstorms Likely" else --> "Thunderstorms" OR if qualifier = "Damaging Winds" OR qualifier = "Large Hail" OR qualifier = "Tornados" --> "Severe Tstms"
T AND (PoP >= 10) AND (sky <= 60)	if \$coverage = "chance" OR "slight chance" --> "Chance Thunderstorms" else if \$coverage = "likely" --> "Thunderstorms Likely" else --> "Thunderstorms" OR if qualifier = "Damaging Winds" OR qualifier = "Large Hail" OR qualifier = "Tornados" --> "Severe Tstms"
IP AND (S OR SW) AND (PoP >= 20)	if \$coverage = "chance" OR "slight chance" --> "Chance Snow/Sleet" else if \$coverage = "likely" --> "Snow/Sleet Likely" else --> "Snow/Sleet"

Weather Condition	Weather Summary Phrase
IP AND (R OR RW) AND (PoP >= 20)	if \$coverage = "chance" OR "slight chance" --> "Chance Rain/Sleet" else if \$coverage = "likely" --> "Rain/Sleet Likely" else --> "Rain/Sleet"
IP AND (ZL OR ZR) AND (PoP >= 20)	Wintry Mix
(R OR RW) AND (ZL OR ZR) AND (PoP >= 20)	if \$coverage = "chance" OR "slight chance" --> "Chance Rain/Freezing Rain" else if \$coverage = "likely" --> "Rain/Freezing Rain Likely" else --> "Rain/Freezing Rain"
(ZR OR ZL) AND (S OR SW) AND (PoP >= 20)	Wintry Mix
ZL AND (PoP >= 20)	if \$coverage = "chance" OR "slight chance" --> "Chance Freezing Drizzle" else if \$coverage = "likely" --> "Freezing Drizzle Likely" else --> "Freezing Drizzle"
ZR AND (PoP >= 20)	if coverage = "chance" OR "slight chance" --> "Chance Freezing Rain" else if coverage = "likely" --> "Freezing Rain Likely" else --> "Freezing Rain"
(R OR RW) AND (S OR SW) AND (PoP >= 20)	if coverage = "chance" OR "slight chance" --> "Chance Rain/Snow" else if coverage = "likely" --> "Rain/Snow Likely" else --> "Rain/Snow"
S AND (PoP >= 20)	if \$coverage = "chance" OR "slight chance" --> "Chance Snow" else if \$coverage = "likely" --> "Snow Likely" else --> "Snow" OR if qualifier = "heavy" --> "Heavy Snow"
(S OR SW) AND (PoP >= 20) AND (Int = '--')	if \$coverage = "chance" OR "slight chance" --> "Chance Flurries" else if \$coverage = "likely" --> "Flurries Likely" else --> "Flurries"
SW AND (PoP >= 20) AND (Int != '--') AND (sky <= 60)	if \$coverage = "chance" OR "slight chance" --> "Chance Snow Showers" else if \$coverage = "likely" --> "Snow Showers Likely" else --> "Snow Showers"
SW AND (PoP >= 20) AND (Int != '--') AND (sky > 60)	if \$coverage = "chance" OR "slight chance" --> "Chance Snow Showers" else if \$coverage = "likely" --> "Snow Showers Likely" else --> "Snow Showers"
L AND (PoP >= 20)	if \$coverage = "chance" OR "slight chance" --> "Chance Drizzle" else if \$coverage = "likely" --> "Drizzle Likely" else --> "Drizzle"
R AND (PoP >= 20)	if \$coverage = "chance" OR "slight chance" --> "Chance Rain" else if \$coverage = "likely" --> "Rain Likely" else --> "Rain" OR if qualifier = "heavy" --> "Heavy Rain"
RW AND (PoP >= 20) AND (sky <= 60)	if \$coverage = "chance" OR "slight chance" --> "Chance Rain Showers" else if \$coverage = "likely" --> "Rain Showers Likely" else --> "Rain Showers"
RW AND (PoP >= 20) AND (sky > 60)	if \$coverage = "chance" OR "slight chance" --> "Chance Rain Showers" else if \$coverage = "likely" --> "Rain Showers Likely" else --> "Rain Showers"
IP AND (PoP >= 20)	Sleet
K	if \$coverage = "patchy" OR "areas" --> "\$coverage Smoke" else --> "Smoke"
ZF	if \$coverage = "patchy" OR "areas" --> "\$coverage Freezing Fog" else --> "Freezing Fog"
IF	if \$coverage = "patchy" OR "areas" --> "\$coverage Ice Fog" else --> "Ice Fog"
H	if \$coverage = "patchy" OR "areas" --> "\$coverage Haze" else --> "Haze"

Weather Condition	Weather Summary Phrase
BN	Blowing Sand
BD	Blowing Dust
BS	Blowing Snow
F	if intensity = heavy --> "Dense Fog" else (if \$coverage = "patchy" OR "areas" --> "\$coverage Fog" else --> "Fog")
(wind >= 15)	if wind speed > 25 mph --> "Windy" else if (wind speed > 15 AND wind direction is between NE and NW AND the date is between 1 October and 1 April AND the maximum temperature is less than 32 --> "Blustery") else if (wind speed > 15 --> "Breezy")
(MaxT < 32)	Cold
(MaxT > 95)	Hot
(sky <= 101)	Cloudy
(sky <= 90)	Mostly Cloudy
(sky <70)	Partly Cloudy
(sky <40)	Mostly Sunny
(sky <= 15)	Sunny
Cloud Category change > 2	Increasing Clouds
Cloud Category change > 2 AND max cloud is cloudy	Becoming Cloudy
Cloud Category change < 3	Clearing
Cloud Category change < 3 AND time of change > 12 hours	Gradual Clearing
Cloud Category change < 3 AND time of change > 12 hours AND late in forecast period	Clearing Late
Cloud Category change < 3 AND time of change < 12 hours	Decreasing Clouds
Cloud Category change < 3 AND max cloud is clear	Becoming Sunny

Table 12: NDFDgenByDay Weather Summary Phrases (format = '12 hourly' or '24 hourly') (priority in ascending order).

Weather Condition	Weather Summary Phrase
(sky <= 15) AND is nighttime	Clear
(sky < 40) AND is nighttime	Mostly Clear

Table 13: NDFDgenByDay Weather Summary Phrases (format = '12 hourly') (priority in ascending order).

Appendix F: References

1. The National Digital Forecast Database Development web site
(<http://onestop.noaa3.awips.noaa.gov/ndfd/index.html>)
2. National Weather Service Instruction 10-506 (DRAFT), Digital Data Products/Services Specification
(http://www.nws.noaa.gov/ost/ifps_sst/10-506.pdf)
3. National Weather Service Instruction 10-503, Public Weather Services
(<http://www.nws.noaa.gov/directives/sym/pd01005003curr.pdf>)
4. National Weather Service Instruction 10-310, Marine and Coastal Weather Service Program
(<http://www.nws.noaa.gov/directives/010/pd01003010c.pdf>)
5. FM 92-XII GRIB General Regularly-distributed Information in Binary Form
(http://www.nws.noaa.gov/tdl/iwt/grib2/frameset_grib2.htm)
6. Description of the AVN MAV MOS Alphanumeric Message
(<http://www.nws.noaa.gov/mdl/synop/mavcard.htm>)
7. Definitions of AVN MOS Weather Elements
(<http://www.nws.noaa.gov/mdl/synop/avnacronym.htm>)